



---

## Hand-Held Devices II



## Software Configuration Manual

---

Datalogic Scanning, Inc.  
959 Terry Street  
Eugene, Oregon 97402  
Telephone: (541) 683-5700  
Fax: (541) 345-7140

An Unpublished Work - All rights reserved. No part of the contents of this documentation or the procedures described therein may be reproduced or transmitted in any form or by any means without prior written permission of Datalogic Scanning, Inc. or its subsidiaries or affiliates ("Datalogic" or "Datalogic Scanning"). Owners of Datalogic products are hereby granted a non-exclusive, revocable license to reproduce and transmit this documentation for the purchaser's own internal business purposes. Purchaser shall not remove or alter any proprietary notices, including copyright notices, contained in this documentation and shall ensure that all notices appear on any reproductions of the documentation.

Should future revisions of this manual be published, you can acquire printed versions by contacting your Datalogic representative. Electronic versions may either be downloadable from the Datalogic website ([www.scanning.datalogic.com](http://www.scanning.datalogic.com)) or provided on appropriate media. If you visit our website and would like to make comments or suggestions about this or other Datalogic publications, please let us know via the "Contact Datalogic" page.

### **Disclaimer**

Datalogic has taken reasonable measures to provide information in this manual that is complete and accurate, however, Datalogic reserves the right to change any specification at any time without prior notice. Datalogic is a registered trademark of Datalogic S.p.A. in many countries and the Datalogic logo is a trademark of Datalogic S.p.A. all licensed to Datalogic Scanning, Inc. All other trademarks and trade names referred to herein are property of their respective owners.

# CONTENTS

---

|   |   |           |
|---|---|-----------|
| 1 | INTRODUCTION .....  | 1         |
| 2 | INITIAL SETUP .....                                       | 3         |
| 3 | CONFIGURATION.....  | 12        |
|   | <b>USB PARAMETERS .....</b>                               | <b>13</b> |
|   | Handshaking.....  | 14        |
|   | Ack/Nack Protocol.....                                    | 14        |
|   | Fifo.....   | 15        |
|   | Inter-character Delay .....                               | 15        |
|   | Rx Timeout.....   | 16        |
|   | Serial Trigger Lock .....                                 | 16        |
|   | Keyboard Nationality.....                                 | 17        |
|   | Fifo.....   | 18        |
|   | Inter-character Delay .....                               | 18        |
|   | Inter-code Delay.....                                     | 18        |
|   | Control Character Emulation.....                          | 19        |
|   | <b>RS232 PARAMETERS.....</b>                              | <b>20</b> |
|   | Baud Rate .....   | 21        |
|   | Parity.....   | 22        |
|   | Data Bits .....   | 22        |
|   | Stop Bits.....  | 23        |
|   | Handshaking.....  | 23        |
|   | Ack/Nack Protocol.....                                    | 24        |
|   | Fifo.....   | 24        |
|   | Inter-character Delay .....                               | 25        |
|   | Rx Timeout.....   | 25        |
|   | Serial Trigger Lock .....                                 | 26        |
|   | <b>WEDGE PARAMETERS .....</b>                             | <b>27</b> |
|   | Keyboard Nationality.....                                 | 29        |
|   | Caps Lock .....   | 30        |
|   | Caps Lock Auto-Recognition (IBM AT compatible only) ..... | 30        |
|   | Num Lock.....   | 31        |
|   | Inter-character Delay .....                               | 31        |
|   | Inter-code Delay.....                                     | 32        |
|   | Control Character Emulation.....                          | 32        |
|   | Keyboard Setting .....                                    | 33        |
|   | <b>PEN EMULATION .....</b>                                | <b>35</b> |
|   | Operating Mode .....                                      | 36        |

|                                       |           |
|---------------------------------------|-----------|
| Minimum Output Pulse.....             | 37        |
| Conversion to Code 39 .....           | 38        |
| Overflow.....                         | 38        |
| Output Level.....                     | 39        |
| Idle Level.....                       | 39        |
| Inter-Block Delay.....                | 40        |
| <b>IBM 46xx .....</b>                 | <b>41</b> |
| IBM Data Formatting.....              | 42        |
| <b>DATA FORMAT.....</b>               | <b>43</b> |
| Code Identifier.....                  | 46        |
| Custom Code Identifier .....          | 47        |
| Header .....                          | 48        |
| Terminator.....                       | 49        |
| Field Adjustment .....                | 50        |
| Field Adjustment Character.....       | 51        |
| Code Length Tx .....                  | 51        |
| Character Replacement .....           | 53        |
| <b>POWER SAVE.....</b>                | <b>56</b> |
| Scan Rate .....                       | 57        |
| Sleep State/USB Suspend .....         | 57        |
| Enter Sleep Timeout .....             | 58        |
| Standby.....                          | 58        |
| <b>READING PARAMETERS .....</b>       | <b>59</b> |
| Hand-Held Operation .....             | 60        |
| Stand Operation.....                  | 60        |
| Hardware Trigger Signal .....         | 61        |
| Trigger-off Timeout .....             | 61        |
| Flash Mode .....                      | 62        |
| Reads per Cycle .....                 | 62        |
| Safety Time.....                      | 63        |
| Beeper Intensity.....                 | 63        |
| Beeper Tone .....                     | 64        |
| Beeper Type .....                     | 64        |
| Beeper Length .....                   | 64        |
| Good Read Spot Duration.....          | 65        |
| Stand Recognition Beep .....          | 65        |
| Automatic Operation Aiming Light..... | 66        |
| Aiming System .....                   | 66        |
| <b>DECODING PARAMETERS.....</b>       | <b>67</b> |
| Ink Spread.....                       | 68        |
| Overflow Control .....                | 68        |
| Interdigit Control.....               | 69        |

|          |  |            |
|----------|--|------------|
|          | Decoding Safety.....                   | 69         |
|          | Puzzle Solver™ .....                   | 70         |
|          | <b>CODE SELECTION .....</b>            | <b>71</b>  |
|          | EAN/UPC Family .....                   | 73         |
|          | 2/5 Family .....                       | 77         |
|          | Code 39 Family.....                    | 78         |
|          | Code 128 Family.....                   | 80         |
|          | Code 93 .....                          | 81         |
|          | Codabar Family.....                    | 82         |
|          | MSI .....                              | 84         |
|          | Plessey .....                          | 85         |
|          | Telepen.....                           | 86         |
|          | Delta IBM .....                        | 87         |
|          | Code 11 .....                          | 88         |
|          | Code 16K.....                          | 89         |
|          | Code 49 .....                          | 89         |
|          | RSS Codes .....                        | 90         |
|          | <b>ADVANCED FORMATTING.....</b>        | <b>91</b>  |
|          | Concatenation.....                     | 92         |
|          | Advanced Formatting.....               | 95         |
| <b>4</b> | <b>REFERENCES .....</b>                | <b>113</b> |
|          | A     HOST CONFIGURATION STRINGS ..... | 129        |
|          | B     CODE IDENTIFIER TABLE.....       | 141        |
| <b>C</b> | <b>HEX AND NUMERIC TABLE .....</b>     | <b>139</b> |

# CONFIGURATION METHODS

---

## Reading Configuration Barcodes

If you wish to change the default settings, this manual provides complete configuration of your reader in an easy way:

**To configure your reader:**

- 1) Open the folded page in [Appendix C](#) with the hex-numeric table and keep it open during the device configuration.
- 2) Read the **Enter Configuration** code ONCE, available at the top of each page of configuration.
- 3) Modify the desired parameters in one or more sections following the procedures given for each group.
- 4) Read the **Exit and Save Configuration** code ONCE, available at the top of each page of configuration.

Reference notes describing the operation of the more complex parameters are given in chapter 4.

## Using DL Sm@rtSet

DL Sm@rtSet is a Windows-based utility program providing a quick and user-friendly configuration method via the RS232 or USB-COM interfaces.

It also allows upgrading the software of the connected device (see the DL Sm@rtSet User's Manual for more details).

## Copy Command

A previously configured reader (Master device), can be used to send its configuration directly to other readers of the same type. The particular procedure for each device is given in par. 4.9.

## **Sending Configuration Strings from Host**

An alternative configuration method is provided in Appendix A using the RS232 or USB interfaces. This method is particularly useful when many devices need to be configured with the same settings. Batch files containing the desired parameter settings can be prepared to configure devices quickly and easily.





# 1 INTRODUCTION

---

This manual provides all the necessary information for complete software configuration of various Datalogic families of second generation Hand-Held Devices (**HHD II**), including CCD guns and readers and laser scanners.

Your reader contains a built-in decoder and multi-standard interface.

It is designed for use in a wide variety of applications and environments including **commercial**, **office automation**, **retail**, and **light industrial** applications where large quantities of information need to be collected rapidly, easily and reliably.

It has several status indicator functions which are described in the next paragraph.

## 1.1 STATUS INDICATORS

Several status indicators are available depending on the type of reader: LEDs, Beeper, and Good Read Spot (for CCD Long Range readers only). They signal several operating conditions which are described in the tables below.

H = high tone

L = low tone

### READER START-UP

| Beeper <sup>1</sup>   | Meaning  |
|-----------------------|--|
| L L L L               | Parameters loaded correctly  |
| H H H H<br>long tones | Parameter loading error, reading or writing error in the non volatile memory |
| H L H L               | Hardware error in EEPROM   |
| OFF                   | No beeper performed when illuminator line is kept high at power on.          |

### READER CONFIGURATION

| Beeper <sup>1</sup> | Meaning                             |
|---------------------|-------------------------------------|
| H H H H             | correct entry in Configuration mode |
| L                   | good read of a command              |
| L L L               | command read error                  |
| L H H H H           | exit from Configuration mode        |

### READER DATA ENTRY

| Beeper <sup>1</sup>   | LED | Good Read Spot | Meaning                               |
|-----------------------|-----|----------------|---------------------------------------|
| one beep <sup>2</sup> | ON  | ON             | correct read of a code in normal mode |
|                       | OFF | OFF            | ready to read a code                  |

<sup>1</sup> only the Beeper Intensity command can modify these signals.

<sup>2</sup> the data entry good read tone is user-configurable with all the Beeper commands in the Reading Parameters section.

---

## 2 INITIAL SETUP

---

### 2.1 INTERFACE SELECTION

Follow the procedure to configure the interface required by your application

- USB Interface
- RS232 Interface
- Wedge Interface
- Pen Emulation Interface
- IBM 46xx Interface

#### 2.1.1 USB Interface Configuration

The USB interface is compatible with:

- Windows 98 (and later)
- Mac OS 8.0 (and later)
- IBM POS for Windows
- 4690 Operating System

The USB interface is compatible with:

|                        |                       |
|------------------------|-----------------------|
| Windows 98 (and later) | IBM POS for Windows   |
| Mac OS 8.0 (and later) | 4690 Operating System |

#### START-UP

As with all USB devices, upon connection, the Host performs several checks by communicating with the USB device. During this phase the LED on the device blinks and normal operations are suspended. Two basic conditions must be met before the USB device is ready to read codes, the correct USB driver must be loaded and sufficient power must be supplied to the reader.

For all systems, the correct USB driver for the default USB-KBD interface is included in the Host Operating System and will either be loaded automatically or will be suggested by the O.S. and should therefore be selected from the dialog box (the first time only).

If the Host supplies sufficient power to the reader, the start-up phase ends correctly, the LED stops blinking and the reader emits the beep OK signal.

If the Host does not supply sufficient power to the reader, a dialog box will appear on the Host and the reader will be blocked (LED continues blinking). In this case, disconnect the USB device cable at the Host (LED stops blinking), connect and power-up an external supply to the USB device cable then reconnect the USB device cable to the Host and close the dialog box. The reader emits the beep OK signal. You can now read codes. At this point you can read the USB interface configuration code according to your application. Load drivers from the O.S. (if requested). When configuring the USB-COM interface, the relevant files and drivers must be installed from the USB Device Installation software which can be downloaded from the web site: <http://www.scanning.datalogic.com>.

The reader is ready.

### First Start-Up

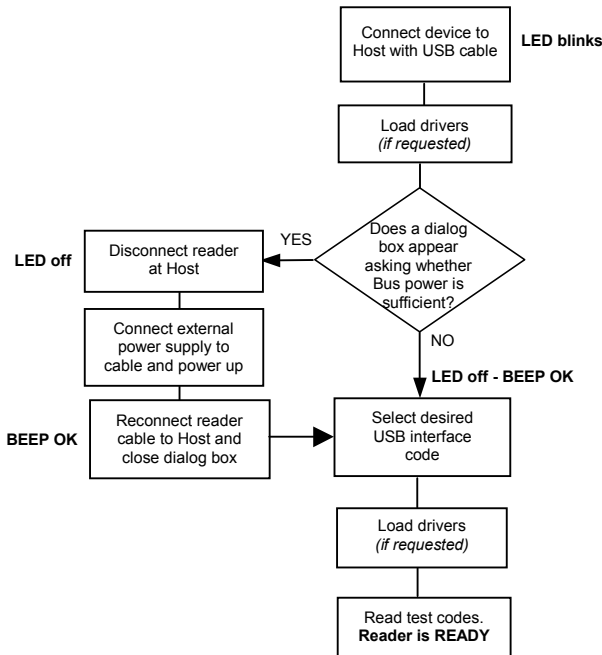

Successive start-ups will automatically recognize the previously loaded drivers. If external power is used, verify that external power is already supplied.

### Successive Start-Ups

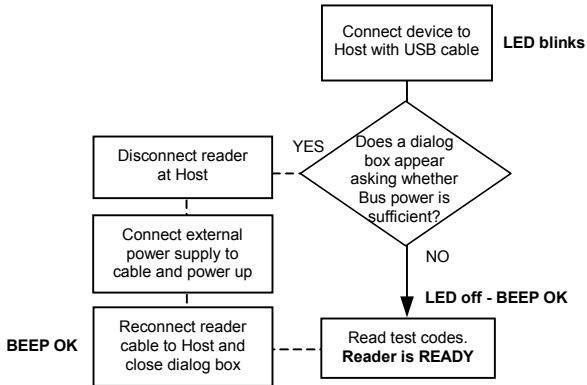

**USB INTERFACE**

USB-KBD



USB-KBD-ALT-MODE



USB-KBD-APPLE



USB-COM\*



USB-IBM-Table Top



USB-IBM-Hand Held



\* When configuring USB-COM, the relevant files and drivers must be installed from the USB Device Installation software which can be downloaded from the web site: (see <http://www.scanning.datalogic.com>).

## 2.1.2 RS232 Interface Selection

Read the restore default code, then read the interface selection code for your application:

### RESTORE DEFAULT



### RS232 INTERFACE

Standard



### POS SYSTEMS

Nixdorf Mode A



Fujitsu



ICL Mode



For POS system default settings refer to par. 4.10.

### 2.1.3 Wedge Interface Selection

Read the restore default code, then read the interface selection code for your application:

**RESTORE DEFAULT**



**WEDGE INTERFACE**

IBM AT or PS/2 PCs



IBM XT



PC Notebook



IBM SURE1



IBM Terminal 3153





**WEDGE INTERFACE (CONTINUED)**

IBM Terminals 31xx, 32xx, 34xx, 37xx:

To select the interface for these IBM Terminals, read the correct KEY TRANSMISSION code. select the KEYBOARD TYPE if necessary (default = advanced keyboard).

**KEY TRANSMISSION MODE**

make-only keyboard



make-break keyboard

**KEYBOARD TYPE**

◆ advanced keyboard



typewriter keyboard

**ALT MODE**

The following interface selection allows barcodes sent to the PC to be interpreted correctly independently from the Keyboard Nationality used. **You do not need to make a Keyboard Nationality selection.**

(default = Num Lock Unchanged). **Make sure the Num Lock key on your keyboard is ON.**

IBM AT - ALT mode



PC Notebook - ALT mode



**WEDGE INTERFACE (CONTINUED)**

**WYSE TERMINALS**

ANSI Keyboard



PC Keyboard



ASCII Keyboard



VT220 style Keyboard



**DIGITAL TERMINALS**

VT2xx/VT3xx/VT4xx



**APPLE**

APPLE ADB Bus



## 2.1.4 Pen Emulation Interface Selection

Read the restore default code, then read the Pen Emulation interface selection code.

**RESTORE DEFAULT**



**PEN EMULATION**



## 2.1.5 IBM 46xx Interface Selection

(IBM Devices only)

**PORT 9B**

4501 Protocol



(typical)

1520 Protocol



**PORT 5B**

1520 Protocol



(typical)

4501 Protocol



## 3 CONFIGURATION

---

Once your reader is setup, you can change the default parameters to meet your application needs. Refer to chapter 2 for initial configuration in order to set the default values and select the interface for your application.

In this manual, the configuration parameters are divided into logical groups making it easy to find the desired function based on its reference group.

The first four groups are for Standard Interface parameter configuration, the fifth is only for IBM 46xx models:

- **USB**
- **RS232**
- **WEDGE**
- **PEN EMULATION**
- **IBM 46xx**

The following parameter groups are common to all interface applications:

**DATA FORMAT** parameters regard the messages sent to the Host system for all interfaces except Pen Emulation.

**POWER SAVE** manages overall current consumption in the reading device.

**READING PARAMETERS** control various operating modes and indicator status functioning.

**DECODING PARAMETERS** maintain correct barcode decoding in certain special reading conditions.

**CODE SELECTION** parameters allow configuration of a personalized mix of codes, code families and their options.

**ADVANCED FORMATTING PARAMETERS** allow code concatenation and advanced formatting of messages towards the Host. It cannot be used with Pen Emulation.

# USB PARAMETERS

|   |  |   |
|---|--|---|
| ⊙ | <b><i>USB-COM</i></b>  | ⊙ |
|   | Handshaking, Ack/Nack protocol, FIFO,<br>Inter-character delay, Rx timeout, Serial<br>trigger lock     |   |
| ⊙ | <b><i>USB-KBD</i></b>  | ⊙ |
|   | Keyboard nationality, FIFO, Inter-character<br>delay, Inter-code delay, Control character<br>emulation |   |
| ⊙ | <b><i>USB-IBM</i></b>  | ⊙ |
|   | No parameter selection required.   |   |

- 1.** Read the **Enter Configuration** code ONCE, available at the top of each page.
- 2.** Read configuration codes from the desired groups.
  - = Read the code and follow the procedure given
  - ◆ = Default value
- 3.** Read the **Exit and Save Configuration** code ONCE, available at the top of each page.



---

***HANDSHAKING***

◆ disable



hardware (RTS/CTS)



software (XON/XOFF)



RTS always ON



See par. 4.1.1 for details.

---

***ACK/NACK PROTOCOL***

◆ disable



enable



See par. 4.1.2 for details.



---

*FIFO*

disable



◆ enable



See par. 4.1.3 for details.

---

*INTER-CHARACTER DELAY*

delay between characters transmitted to Host

**Read 2 numbers from the table where:**

00 = DELAY disabled

01-99 = DELAY from **1** to **99** milliseconds

◆ delay disabled



## *RX TIMEOUT*

timeout control in reception from Host



**Read 2 numbers from the table where:**

00 = TIMEOUT disabled

01-99 = TIMEOUT from **.1** to **9.9** seconds

◆ rx timeout 5 seconds

See par. 4.1.4 for details.

## *SERIAL TRIGGER LOCK*

◆ disabled



enable and select characters



**Read 2 characters from the Hex/Numeric table in the range 00-FE where:**

- First Character enables device trigger
- Second Character inhibits device trigger until the first character is received again.





---

***KEYBOARD NATIONALITY*****Not Available for USB-KBD-ALT-MODE Interface**

This parameter default value is restored through the Interface Selection code and not Restore Default.

Belgian



English



French



German



Italian



Japanese



Spanish



Swedish



◆ USA





## *FIFO*

disable



◆ enable



See par. 4.1.3 for details.

## *INTER-CHARACTER DELAY*

delay between characters transmitted to Host



**Read 2 numbers from the table where:**

00 = DELAY disabled

01-99 = DELAY from **1** to **99** milliseconds

◆ delay disabled

## *INTER-CODE DELAY*

delay between codes transmitted to Host



**Read 2 numbers from the table where:**

00 = DELAY disabled

01-99 = DELAY from **1** to **99** seconds

◆ delay disabled



---

***CONTROL CHARACTER EMULATION***

◆ CTRL+ Shift + Key



CTRL + Key



# RS232 PARAMETERS

|   |                              |   |
|---|------------------------------|---|
| ⊙ | <i>BAUD RATE</i>             | ⊙ |
| ⊙ | <i>PARITY</i>                | ⊙ |
| ⊙ | <i>DATA BITS</i>             | ⊙ |
| ⊙ | <i>STOP BITS</i>             | ⊙ |
| ⊙ | <i>HANDSHAKING</i>           | ⊙ |
| ⊙ | <i>ACK/NACK PROTOCOL</i>     | ⊙ |
| ⊙ | <i>FIFO</i>                  | ⊙ |
| ⊙ | <i>INTER-CHARACTER DELAY</i> | ⊙ |
| ⊙ | <i>RX TIMEOUT</i>            | ⊙ |
| ⊙ | <i>SERIAL TRIGGER LOCK</i>   | ⊙ |

**1.** Read the **Enter Configuration** code ONCE, available at the top of each page.

**2.** Read configuration codes from the desired groups.

= Read the code and follow the procedure given

◆ = Default value

**3.** Read the **Exit and Save Configuration** code ONCE, available at the top of each page.



---

***BAUD RATE***

300 baud



600 baud



1200 baud



2400 baud



4800 baud



◆ 9600 baud



19200 baud



38400 baud





# RS232



## *PARITY*

◆ none



even parity



odd parity



## *DATA BITS*

7 bits



◆ 8 bits



9 bits





---

***STOP BITS***

◆ 1 stop bit



2 stop bits



---

***HANDSHAKING***

◆ disable



hardware (RTS/CTS)



software (XON/XOFF)



RTS always ON



See par. 4.1.1 for details.



---

***ACK/NACK PROTOCOL***

◆ disable



enable



See par. 4.1.2 for details.

---

***FIFO***

disable



◆ enable



See par. 4.1.3 for details.





---

***INTER-CHARACTER DELAY***

delay between characters transmitted to Host



**Read 2 numbers from the table where:**

00 = DELAY disabled

01-99 = DELAY from 1 to 99 milliseconds

◆ delay disabled

---

***RX TIMEOUT***

timeout control in reception from Host



**Read 2 numbers from the table where:**

00 = TIMEOUT disabled

01-99 = TIMEOUT from .1 to 9.9 seconds

◆ rx timeout 5 seconds

See par. 4.1.4 for details.



---

***SERIAL TRIGGER LOCK***

◆ disabled



enable and select characters



**Read 2 characters from the Hex/Numeric table in the range 00-FE where:**

- First Character enables device trigger
- Second Character inhibits device trigger until the first character is received again.

# WEDGE PARAMETERS

|   |                              |   |
|---|------------------------------|---|
| ⊙ | <i>KEYBOARD NATIONALITY</i>  | ⊙ |
| ⊙ | <i>CAPS LOCK</i>             | ⊙ |
| ⊙ | <i>CAPS LOCK</i>             | ⊙ |
| ⊙ | <i>AUTO-RECOGNITION</i>      | ⊙ |
| ⊙ | <i>NUM LOCK</i>              | ⊙ |
| ⊙ | <i>INTER-CHARACTER DELAY</i> | ⊙ |
| ⊙ | <i>INTER-CODE DELAY</i>      | ⊙ |
| ⊙ | <i>CONTROL CHARACTER</i>     | ⊙ |
| ⊙ | <i>EMULATION</i>             | ⊙ |
| ⊙ | <i>KEYBOARD SETTING</i>      | ⊙ |

**1.** Read the **Enter Configuration** code ONCE, available at the top of each page.

**2.** Read configuration codes from the desired groups.

= Read the code and follow the procedure given

◆ = Default value

**3.** Read the **Exit and Save Configuration** code ONCE, available at the top of each page.



**WEDGE*****KEYBOARD NATIONALITY***

This parameter default value is restored through the Interface Selection code and not Restore Default.

Belgian



English



French



German



Italian



Spanish



Swedish



◆ USA



The Japanese Keyboard Nationality selection is valid only for IBM AT compatible PCs.

Japanese





---

***CAPS LOCK***

◆ caps lock OFF



caps lock ON



Select the appropriate code to match your keyboard caps lock status.

**Note:** Caps lock manual configuration is ignored when Caps Lock Auto-Recognition is enabled.

For **PC Notebook** interface selections, the caps lock status is automatically recognized, therefore this command is not necessary.

---

***CAPS LOCK AUTO-RECOGNITION (IBM AT COMPATIBLE ONLY)***

disable



◆ enable





## WEDGE

---

### *NUM LOCK*

toggle num lock



◆ num lock unchanged



This selection is used together with the Alt Mode interface selection for AT or Notebook PCs.

It changes the way the Alt Mode procedure is executed, therefore it should be set as follows:

- if your keyboard Num Lock is normally on use **num lock unchanged**
- if your keyboard Num Lock is normally off use **toggle num lock**

In this way the device will execute the Alt Mode procedure correctly for your application.

---

### *INTER-CHARACTER DELAY*

delay between characters transmitted to Host



**Read 2 numbers from the table where:**

00 = DELAY disabled  
01-99 = DELAY from **1** to **99** milliseconds

◆ delay disabled



---

***INTER-CODE DELAY***

delay between codes transmitted to Host



**Read 2 numbers from the table where:**

00 = DELAY disabled

01-99 = DELAY from 1 to 99 seconds

◆ delay disabled

---

***CONTROL CHARACTER EMULATION***

◆ CTRL+ Shift + Key



CTRL + Key







# WEDGE

---

## *KEYBOARD SETTING*

### ALPHANUMERIC KEYBOARD SETTING

The reader can be used with terminals or PCs with various keyboard types and nationalities through a simple keyboard setting procedure.

The type of computer or terminal must be selected before activating the keyboard setting command.

Keyboard setting consists of communicating to the reader how to send data corresponding to the keyboard used in the application. The keys must be set in a specific order.

Press and release a key to set it.

Some characters may require more than one key pressed simultaneously during normal use (refer to the manual of your PC or terminal for keyboard use). The exact sequence must be indicated to the reader in this case pressing and releasing the different keys.

#### **Example:**

If one has to press the "Shift" and "4" keys simultaneously on the keyboard to transmit the character "\$" to the video, to set the "\$", press and release "Shift" then press and release "4".

Each pressed and released key must generate an acoustic signal on the reader, otherwise repress the key. Never press more than one key at the same time, even if this corresponds to the normal use of your keyboard.

**Press "Backspace" to correct a wrong key entry. In this case the reader emits 2 beeps.**

**Note: "CAPS LOCK" and "NUM LOCK" must be off before starting the keyboard setting procedure. "SHIFT" must be repressed for each character and cannot be substituted by "CAPS LOCK".**

setting the alphanumeric keyboard



Read the code above.

Press the keys shown in the following table according to their numerical order:



## WEDGE



Some ASCII characters may be missing as this depends on the type of keyboard: these are generally particular characters relative to the various national symbologies. In this case:

- **The first 4 characters (Shift, Alt, Ctrl, and Backspace) can only be substituted with keys not used, or substituted with each other.**
- characters can be substituted with other single symbols (e.g. "SPACE") even if not included in the barcode set used.
- characters can be substituted with others corresponding to your keyboard.

**The reader signals the end of the procedure with 2 beeps indicating the keys have been registered.**

|                       |                  |                            |
|-----------------------|------------------|----------------------------|
| 01 : <b>Shift</b>     |                  |                            |
| 02 : <b>Alt</b>       |                  |                            |
| 03 : <b>Ctrl</b>      |                  |                            |
| 04 : <b>Backspace</b> |                  |                            |
| 05 : <b>SPACE</b>     | 28 : <b>7</b>    | 51 : <b>N</b>              |
| 06 : <b>!</b>         | 29 : <b>8</b>    | 52 : <b>O</b>              |
| 07 : <b>"</b>         | 30 : <b>9</b>    | 53 : <b>P</b>              |
| 08 : <b>#</b>         | 31 : <b>:</b>    | 54 : <b>Q</b>              |
| 09 : <b>\$</b>        | 32 : <b>;</b>    | 55 : <b>R</b>              |
| 10 : <b>%</b>         | 33 : <b>&lt;</b> | 56 : <b>S</b>              |
| 11 : <b>&amp;</b>     | 34 : <b>=</b>    | 57 : <b>T</b>              |
| 12 : <b>'</b>         | 35 : <b>&gt;</b> | 58 : <b>U</b>              |
| 13 : <b>(</b>         | 36 : <b>?</b>    | 59 : <b>V</b>              |
| 14 : <b>)</b>         | 37 : <b>@</b>    | 60 : <b>W</b>              |
| 15 : <b>*</b>         | 38 : <b>A</b>    | 61 : <b>X</b>              |
| 16 : <b>+</b>         | 39 : <b>B</b>    | 62 : <b>Y</b>              |
| 17 : <b>,</b>         | 40 : <b>C</b>    | 63 : <b>Z</b>              |
| 18 : <b>-</b>         | 41 : <b>D</b>    | 64 : <b>[</b>              |
| 19 : <b>.</b>         | 42 : <b>E</b>    | 65 : <b>\</b>              |
| 20 : <b>/</b>         | 43 : <b>F</b>    | 66 : <b>]</b>              |
| 21 : <b>0</b>         | 44 : <b>G</b>    | 67 : <b>^</b>              |
| 22 : <b>1</b>         | 45 : <b>H</b>    | 68 : <b>_</b> (underscore) |
| 23 : <b>2</b>         | 46 : <b>I</b>    | 69 : <b>`</b>              |
| 24 : <b>3</b>         | 47 : <b>J</b>    | 70 : <b>{</b>              |
| 25 : <b>4</b>         | 48 : <b>K</b>    | 71 : <b> </b>              |
| 26 : <b>5</b>         | 49 : <b>L</b>    | 72 : <b>}</b>              |
| 27 : <b>6</b>         | 50 : <b>M</b>    | 73 : <b>~</b>              |
|                       |                  | 74 : <b>DEL</b>            |

# PEN EMULATION

|   |                              |   |
|---|------------------------------|---|
| ⊙ | <i>OPERATING MODE</i>        | ⊙ |
| ⊙ | <i>MINIMUM OUTPUT PULSE</i>  | ⊙ |
| ⊙ | <i>CONVERSION TO CODE 39</i> | ⊙ |
| ⊙ | <i>OVERFLOW</i>              | ⊙ |
| ⊙ | <i>OUTPUT LEVEL</i>          | ⊙ |
| ⊙ | <i>IDLE LEVEL</i>            | ⊙ |
| ⊙ | <i>INTER-BLOCK DELAY</i>     | ⊙ |

**1.** Read the **Enter Configuration** code ONCE, available at the top of each page.

**2.** Read configuration codes from the desired groups.

◆ = Default value

**3.** Read the **Exit and Save Configuration** code ONCE, available at the top of each page.

The operating mode parameters are complete commands and do not require reading the Enter and Exit configuration codes.

---

---

### *OPERATING MODE*

◆ interpret mode



Interprets commands without sending them to the decoder.

transparent mode



Sends commands to the decoder without interpreting them.



---

***MINIMUM OUTPUT PULSE***



See par. 4.2.1 for details.



### *CONVERSION TO CODE 39*

▶ disable conversion to Code 39



Transmits codes in their original format.

enable conversion to Code 39



Converts codes read into Code 39 format.

See par. 4.2.2 for details.

### *OVERFLOW*

narrow



◆ medium



wide



See par. 4.2.3 for details.



---

***OUTPUT LEVEL***

◆ normal  
(white = logic level 0)



inverted  
(white = logic level 1)



See par. 4.2.4 for details.

---

***IDLE LEVEL***

◆ normal  
(black level)



inverted  
(white level)



See par. 4.2.4 for details.



---

***INTER-BLOCK DELAY***

delay between character blocks transmitted to Host

**Read 2 numbers from the table where:**

00 = DELAY disabled

01-99 = DELAY from .1 to **9.9** seconds

◆ delay disabled

See par. 4.2.5 for details.





# IBM 46XX



## *IBM DATA FORMATTING*



- 1.** Read the **Enter Configuration** code ONCE, available at the top of each page.
- 2.** Read configuration codes from the desired groups.

◆ = Default value

- 3.** Read the **Exit and Save Configuration** code ONCE, available at the top of each page.



---

***IBM DATA FORMATTING***

conversion to Code 39



◆ IBM Standard



mixed IBM Standard + Code 39



See par. 4.3.1 for details.



# DATA FORMAT

NOT FOR PEN INTERFACES

|   |                               |   |
|---|-------------------------------|---|
| ⊙ | <i>CODE IDENTIFIER</i>        | ⊙ |
| ⊙ | <i>CUSTOM CODE IDENTIFIER</i> | ⊙ |
| ⊙ | <i>HEADER</i>                 | ⊙ |
| ⊙ | <i>TERMINATOR</i>             | ⊙ |
| ⊙ | <i>FIELD ADJUSTMENT</i>       | ⊙ |
| ⊙ | <i>FIELD ADJ. CHARACTER</i>   | ⊙ |
| ⊙ | <i>CODE LENGTH TX</i>         | ⊙ |
| ⊙ | <i>CHARACTER REPLACEMENT</i>  | ⊙ |

**1.** Read the **Enter Configuration** code ONCE, available at the top of each page.

**2.** Read configuration codes from the desired groups.

= Read the code and follow the procedure given

◆ = Default value

**3.** Read the **Exit and Save Configuration** code ONCE, available at the top of each page.

## DATA FORMAT

| <b>CODE IDENTIFIER TABLE</b>    |              |                    |        |
|---------------------------------|--------------|--------------------|--------|
| CODE                            | AIM STANDARD | DATALOGIC STANDARD | Custom |
| 2/5 interleaved                 | ] I y        | N                  |        |
| 2/5 industrial                  | ] X y        | P                  |        |
| 2/5 normal 5 bars               | ] S y        | O                  |        |
| 2/5 matrix 3 bars               | ] X y        | Q                  |        |
| EAN 8                           | ] E 4        | A                  |        |
| EAN 13                          | ] E 0        | B                  |        |
| UPC A                           | ] X y        | C                  |        |
| UPC E                           | ] X y        | D                  |        |
| EAN 8 with 2 ADD ON             | ] E 5        | J                  |        |
| EAN 8 with 5 ADD ON             | ] E 6        | K                  |        |
| EAN 13 with 2 ADD ON            | ] E 1        | L                  |        |
| EAN 13 with 5 ADD ON            | ] E 2        | M                  |        |
| UPC A with 2 ADD ON             | ] X y        | F                  |        |
| UPC A with 5 ADD ON             | ] X y        | G                  |        |
| UPC E with 2 ADD ON             | ] X y        | H                  |        |
| UPC E with 5 ADD ON             | ] X y        | I                  |        |
| Code 39                         | ] A y        | V                  |        |
| Code 39 Full ASCII              | ] A y        | W                  |        |
| CODABAR                         | ] F y        | R                  |        |
| ABC CODABAR                     | ] X y        | S                  |        |
| Code 128                        | ] C y        | T                  |        |
| EAN 128                         | ] C y        | k                  |        |
| ISBT 128                        | ] C4         | f                  |        |
| Code 93                         | ] G y        | U                  |        |
| CIP/39                          | ] X y        | Y                  |        |
| CIP/HR                          | ] X y        | e                  |        |
| Code 32                         | ] X y        | X                  |        |
| MSI                             | ] M y        | Z                  |        |
| Plessey Standard                | ] P 0        | a                  |        |
| Plessey Anker                   | ] P 1        | o                  |        |
| Telepen                         | ] X 0        | d                  |        |
| Delta IBM                       | ] X 0        | c                  |        |
| Code 11                         | ] H y        | b                  |        |
| Code 16K                        | ] K 0        | p                  |        |
| Code 49                         | ] T y        | q                  |        |
| RSS Expanded Linear and Stacked | ] e 0        | t                  |        |
| RSS Limited                     | ] e 0        | v                  |        |
| RSS 14 Linear and Stacked       | ] e 0        | u                  |        |

## DATA FORMAT

---

- AIM standard identifiers are not defined for all codes: the X identifier is assigned to the code for which the standard is not defined. The y value depends on the selected options (check digit tested or not, check digit tx or not, etc.).
- When customizing the Datalogic Standard code identifiers, 1 or 2 identifier characters can be defined for each code type. If only 1 identifier character is required, the second character must be selected as **FF** (disabled).
- The code identifier can be singly disabled for any code by simply selecting **FF** as the first identifier character.
- Write in the Custom character identifiers in the table above for your records.



## DATA FORMAT



---

### *CODE IDENTIFIER*

◆ disable



Datalogic standard



AIM standard



custom





---

### *CUSTOM CODE IDENTIFIER*

define custom code identifier(s)



- ① Read the above code.  
(Code Identifiers default to Datalogic standard, see table on previous page).
- ② Select the code type from the code table in Appendix B for the identifier you want to change.
- ③ You can define 1 or 2 identifier characters for each code type. If only 1 identifier character is required, the second character must be selected as **FF** (disabled). Read the hexadecimal value corresponding to the character(s) you want to define as identifiers for the code selected in step ②: valid characters are in the range **00-FD**.

**Example:** To define Code 39 Code Identifier = @

Read      define custom code identifier(s)      +      Code 39      +      40      +      FF

**DATA FORMAT*****HEADER***

no header



one character header



two character header



three character header



four character header



five character header



six character header



seven character header



eight character header



After selecting **one** of the desired Header codes, read the character(s) from the HEX table. Valid characters are in the range **00-FE**.

**Example:**

four character header



+ 41 + 42 + 43 + 44 = Header ABCD





## DATA FORMAT



For more details see par. 4.4.1.

---

### *TERMINATOR*

no terminator



one character terminator



two character terminator



three character terminator



four character terminator



five character terminator



six character terminator



seven character terminator



eight character terminator



After selecting **one** of the desired Header codes, read the character(s) from the HEX table. Valid characters are in the range **00-FE**.

**Example:**

**DATA FORMAT**

two character terminator



+ 0D + 0A = Terminator CR LF

**For more details see par. 4.4.1.*****FIELD ADJUSTMENT***

◆ disable field adjustment



Field adjustment allows a number of characters  $n$ , to be added to or subtracted from the barcode read. The adjustment can be different for each enabled code type. To define the field adjustment:

- ① Read the enable field adjustment code:

enable field adjustment



- ② Select the code type from the Code Identifier Table in Appendix B.  
 ③ Select the type of adjustment to perform:

right addition



left addition



right deletion



left deletion



- ④ Read a number in the range **01 - 32** from the Hex/Numeric Table to define how many characters to add or delete:

**Conditions:**

- Adjustment is only performed on the barcode data, the Code Identifier and Code Length Transmission fields are not modified by the field adjustment parameter.
- If the field setting would subtract more characters than exist in the barcode, the subtraction will take place only to code length 0.
- You can set up to a maximum of 10 different field adjustments on the same barcode family or on different barcode families.

**DATA FORMAT**

**Example:** To add 4 characters to the right of Standard Code 39 Codes:



- ① Read the field adjustment character code:

field adjustment character



- ② Read the hexadecimal value corresponding to the character you want to use for field adjustment. Valid characters are in the range **00-FE**.

**Example:**

To define the field adjustment character = **A**:



---

***CODE LENGTH TX***

◆ code length not transmitted



code length transmitted in variable-digit format



code length transmitted in fixed 4-digit format



Enter Configuration



## DATA FORMAT

Exit and Save Configuration



The code length is transmitted in the message after the Headers and Code Identifier characters. The code length is calculated after performing any field adjustment operations.



---

## *CHARACTER REPLACEMENT*

◆ disable character replacement



This parameter allows up to three characters to be replaced from the barcode read. These substitutions are stored in memory. To define each character replacement:

- ① Read one of the following character replacement codes:

first character replacement



second character replacement



third character replacement



- ② From the Code Identifier Table in Appendix B, read the Code Identifier for the desired code family.  
**0** = character replacement will be effective for all code families.
- ③ From the Hex/Numeric Table read two characters corresponding to the Hex value (**00-FE**) which identifies the character to be replaced.
- ④ From the Hex/Numeric Table read two characters corresponding to the Hex value (**00-FE**) which identifies the new character to replace.

Enter Configuration



## DATA FORMAT

Exit and Save Configuration



**FF** = the character to be replaced will be substituted with no character, that is, it will be removed from the code.

# DATA FORMAT

---

## Example:

The following strings define:

1. *First Character Replacement:* substitution in *Code 39 barcodes* of all occurrences of the **0** character with the **1** character.
2. *Second Character Replacement:* substitution in *Code 39 barcodes* of all occurrences of the **A** character with the **B** character.

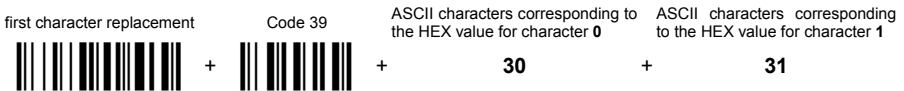

For Code 39 codes containing the string "**0123**", the contents transmitted will be "**1123**".

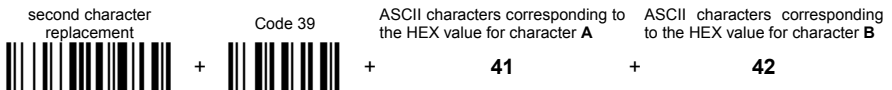

For Code 39 codes containing the string "**ABCD**", the contents transmitted will be "**BBCD**".

# POWER SAVE

|   |                                |   |
|---|--------------------------------|---|
| ⊙ | <i>SCAN RATE</i>               | ⊙ |
| ⊙ | <i>SLEEP STATE/USB SUSPEND</i> | ⊙ |
| ⊙ | <i>ENTER SLEEP TIMEOUT</i>     | ⊙ |
| ⊙ | <i>STANDBY</i>                 | ⊙ |

**1.** Read the **Enter Configuration** code ONCE, available at the top of each page.

**2.** Read configuration codes from the desired groups.

= Read the code and follow the procedure given

◆ = Default value

**3.** Read the **Exit and Save Configuration** code ONCE, available at the top of each page.



**POWER SAVE*****SCAN RATE*****CCD Readers ONLY**

quarter



half



◆ maximum



A lower scan rate reduces power consumption but can lengthen reading response time.

***SLEEP STATE/USB SUSPEND*****ONLY Devices with Button/Trigger**

◆ disable



enable



See par. 4.5.1 for details.



# POWER SAVE

## *ENTER SLEEP TIMEOUT*

**ONLY Devices with Button/Trigger**

enter sleep timeout



**Read 2 numbers in the range 00-99:**

00 = Enter Sleep state immediately

01-99 = corresponds to a max. 9.9 sec. delay before entering the Sleep state.

See par. 4.5.2 for details.

## *STANDBY*

**ONLY for CCD Devices**

◆ disable



optimize for reading speed

enable



optimize for low power consumption

See par. 4.5.3 for details.

# READING PARAMETERS

|   |                                |   |
|---|--------------------------------|---|
| ⊙ | <i>HAND-HELD OPERATION</i>     | ⊙ |
| ⊙ | <i>STAND OPERATION</i>         | ⊙ |
| ⊙ | <i>TRIGGER SIGNAL</i>          | ⊙ |
| ⊙ | <i>TRIGGER-OFF TIMEOUT</i>     | ⊙ |
| ⊙ | <i>FLASH MODE</i>              | ⊙ |
| ⊙ | <i>READS PER CYCLE</i>         | ⊙ |
| ⊙ | <i>SAFETY TIME</i>             | ⊙ |
| ⊙ | <i>BEEPER INTENSITY</i>        | ⊙ |
| ⊙ | <i>BEEPER TONE</i>             | ⊙ |
| ⊙ | <i>BEEPER TYPE</i>             | ⊙ |
| ⊙ | <i>BEEPER LENGTH</i>           | ⊙ |
| ⊙ | <i>GOOD READ SPOT DURATION</i> | ⊙ |
| ⊙ | <i>STAND RECOGNITION BEEP</i>  | ⊙ |
| ⊙ | <i>AUTOMATIC OPERATION</i>     | ⊙ |
|   | <i>AIMING LIGHT</i>            | ⊙ |
| ⊙ | <i>AIMING SYSTEM</i>           | ⊙ |

**1.** Read the **Enter Configuration** code ONCE, available at the top of each page.

**2.** Read configuration codes from the desired groups.

= Read the code and follow the procedure given

◆ = Default value

**3.** Read the **Exit and Save Configuration** code ONCE, available at the top of each page.

---

## ***HAND-HELD OPERATION***

◆ hardware trigger



□ software trigger



always on



♣ automatic



\* hardware trigger ready



---

◆ = default value for devices with trigger

□ = default value for devices without trigger

\* = only for CCD readers with trigger

♣ = only for CCD readers

---

For *Automatic* Hand-Held or Stand Operation, the Safety Time parameter is forced to no code consecutive reading (00).

See par. 4.6.1 for details

---

## ***STAND OPERATION***

**ONLY Devices with Stand Recognition Beep**

hardware trigger



software trigger



always on



◆ ♣ automatic



See par. 4.6.1 for details

***HARDWARE TRIGGER SIGNAL*****ONLY Devices with Button/Trigger**

◆ trigger active level



trigger active pulse



See par. 4.6.2 for details

***TRIGGER-OFF TIMEOUT*****ONLY Devices with Button/Trigger**

trigger-off timeout

**Read 2 numbers in the range 00-99:**

00 = disables the trigger-off timeout

01-99 = corresponds to a max. 99-sec. delay after the trigger press to allow the reader to turn off automatically.

◆ trigger-off timeout disabled

See par. 4.6.3 for details.



## READING PARAMETERS

### *FLASH MODE*

"FLASH" ON duration



"FLASH" OFF duration



**Read 2 numbers in the range 01-99:**

01 to 99 = from .1 to 9.9 seconds.

◆ Flash-ON = 1 sec. Flash-OFF = 0.6 sec

### *READS PER CYCLE*

◆ one read per cycle



multiple reads per cycle



See par. 4.6.4 for details.

**READING PARAMETERS*****SAFETY TIME***

safety time

Limits same code consecutive reading.**Read 2 numbers in the range 00-99:**

00 = no same code consecutive reading until reader is removed (no decoding) for at least 400 ms.

01-99 = timeout from .1 to 9.9 seconds before a consecutive read on same code.

◆ safety time = 0.5 sec

See par. 4.6.5 for details.

***BEEPER INTENSITY***

beeper off \*



low intensity



medium intensity



◆ high intensity



\* This sets the beeper OFF for data entry, while for all other beeper signals it has the meaning "very low intensity". The Beeper Intensity parameter is effective for all operating conditions described in par. 1.1.



# READING PARAMETERS

## *BEEPER TONE*

tone 1



◆ tone 2



tone 3



tone 4



## *BEEPER TYPE*

◆ monotone



bitonal



## *BEEPER LENGTH*

long



◆ short







# READING PARAMETERS

## *GOOD READ SPOT DURATION*

CCD Long Range Readers ONLY

disable



short



◆ medium



long



## *STAND RECOGNITION BEEP*

ONLY Readers with Stand Recognition

disable



◆ enable





# READING PARAMETERS

## *AUTOMATIC OPERATION AIMING LIGHT*

### CCD Long Range Readers ONLY

disable



◆ enable



See par. 4.6.6 for details.

## *AIMING SYSTEM*

### Laser Readers ONLY

◆ disable



300 ms



500 ms



1 sec



See par. 4.6.7 for details.

# DECODING PARAMETERS

|   |                                  |   |
|---|----------------------------------|---|
| ⊙ | <b><i>INK SPREAD</i></b>         | ⊙ |
| ⊙ | <b><i>OVERFLOW CONTROL</i></b>   | ⊙ |
| ⊙ | <b><i>INTERDIGIT CONTROL</i></b> | ⊙ |
| ⊙ | <b><i>DECODING SAFETY</i></b>    | ⊙ |
| ⊙ | <b><i>PUZZLE SOLVER™</i></b>     | ⊙ |



**CAUTION**

*Before changing these parameter values read the descriptions in par. 4.7.*

- 1.** Read the **Enter Configuration** code ONCE, available at the top of each page.
- 2.** Read configuration codes from the desired groups.  
◆ = Default value
- 3.** Read the **Exit and Save Configuration** code ONCE, available at the top of each page.



## DECODING PARAMETERS



---

### *INK SPREAD*

disable



◆ enable



See par. 4.7.1 for details.

---

### *OVERFLOW CONTROL*

disable



◆ enable



See par. 4.7.2 for details.



# DECODING PARAMETERS

## *INTERDIGIT CONTROL*

disable



◆ enable



See par. 4.7.3 for details.

## *DECODING SAFETY*

◆ one read



(decoding safety disabled)

two reads



three reads



four reads



Required number of good reads before accepting code.

***PUZZLE SOLVER™***

◆ disable



enable



In the case of damaged or poorly printed codes, this parameter allows reading multiple parts of the single code to reconstruct it.

To read codes using this technology, simply move the reader over the code so that each line of the code is scanned.

**Conditions:**

- This parameter is only valid for the following codes:

|                                 |                                  |                                 |
|---------------------------------|----------------------------------|---------------------------------|
| <b>EAN 8<br/>without Add-on</b> | <b>EAN 13<br/>without Add-on</b> | <b>UPC A<br/>without Add-on</b> |
| <b>Code 128</b>                 | <b>Code 39</b>                   |                                 |

- For Code 39, Check digit control without transmission is forced.
- PuzzleSolver™ is disabled when code ISBT 128 is enabled.

# CODE SELECTION

|   |                        |   |
|---|------------------------|---|
| ⊙ | <i>EAN/UPC FAMILY</i>  | ⊙ |
| ⊙ | <i>2/5 FAMILY</i>      | ⊙ |
| ⊙ | <i>CODE 39 FAMILY</i>  | ⊙ |
| ⊙ | <i>CODE 128 FAMILY</i> | ⊙ |
| ⊙ | <i>CODABAR FAMILY</i>  | ⊙ |
| ⊙ | <i>CODE 93</i>         | ⊙ |
| ⊙ | <i>MSI</i>             | ⊙ |
| ⊙ | <i>PLESSEY</i>         | ⊙ |
| ⊙ | <i>TELEPEN</i>         | ⊙ |
| ⊙ | <i>DELTA IBM</i>       | ⊙ |
| ⊙ | <i>CODE 11</i>         | ⊙ |
| ⊙ | <i>CODE 16K</i>        | ⊙ |
| ⊙ | <i>CODE 49</i>         | ⊙ |
| ⊙ | <i>RSS CODES</i>       | ⊙ |

**1.** Read the **Enter Configuration** code ONCE, available at the top of each page.

**2.** Read configuration codes from the desired groups.

= Read the code and follow the procedure given

◆ = Default value

**3.** Read the **Exit and Save Configuration** code ONCE, available at the top of each page.



## CODE SELECTION



DISABLES ALL CODE FAMILIES



NOTE

*The reader allows up to 5 code selections. This does not limit the number of CODES enabled to 5, as it depends on the code family.*

**SINGLE  
SELECTIONS =**

- ONE combination code from the EAN family
- ONE code from the 2/5 family

### Example

5 code selections:

1. 2/5 Interleaved
2. 2/5 Industrial
3. Code 128 + EAN 128
4. Code 39 Full ASCII + Code 32
5. UPC A/UPC E

In this section all **SINGLE** code selections are **underlined and in bold**.





## CODE SELECTION

---

### *EAN/UPC FAMILY*

disable the family



- ① Read the desired family code

**Note:**

Since the EAN/UPC without ADD ON code selection is enabled by default, to correctly enable another selection, first disable the family.

#### **EAN 8/EAN 13/UPC A/UPC E with and without ADD ON**



---

#### WITHOUT ADD ON

##### ◆ **EAN 8/EAN 13/UPC A/UPC E**



##### **EAN 8/EAN 13**



##### **UPC A/UPC E**





# CODE SELECTION

WITH ADD ON 2 AND 5

EAN 8/EAN 13/UPC A/UPC E



EAN 8/EAN 13



UPC A/UPC E



WITH ADD ON 2 ONLY

EAN 8/EAN 13



UPC A/UPC E



WITH ADD ON 5 ONLY

EAN 8/EAN 13



UPC A/UPC E





# CODE SELECTION

## EAN/UPC CHECK DIGIT TX SELECTIONS

For each code type in this family you can choose to transmit the check digit or not

### CHECK DIGIT TRANSMISSION

◆ EAN 8



◆ EAN 13



◆ UPC A



◆ UPC E



### NO CHECK DIGIT TRANSMISSION

EAN 8



EAN 13



UPC A



UPC E





## CODE SELECTION

---

### CONVERSION OPTIONS

UPC E to UPC A conversion



UPC E to EAN 13 conversion



UPC A to EAN 13 conversion



EAN 8 to EAN 13 conversion



Enable only ISBN conversion



Enable only ISSN conversion



Enable both ISBN and ISSN conversion



Disable both ISBN and ISSN conversion



**CODE SELECTION****2/5 FAMILY**

disables the family



① Read the desired family code

◆ **Interleaved 2/5****Normal 2/5 (5 Bars)****Industrial 2/5 (IATA)****Matrix 2/5 (3 Bars)**

The pharmaceutical code below is part of the 2/5 family but has no check digit or code length selections.

**Code CIP/HR**

French pharmaceutical code

② Read a check digit selection

**CHECK DIGIT TABLE**

no check digit control



◆ check digit control and transmission



check digit control without transmission

③ Read **4** numbers for the code length where:

- **First 2 digits** = minimum code length.
- **Second 2 digits** = maximum code length.

The maximum code length is **99** characters.

The minimum code length must always be less than or equal to the maximum.

Examples:

**0199** = variable from 1 to 99 digits in the code.

**1010** = 10 digit code length only.



# CODE SELECTION

## CODE 39 FAMILY

disables the family



① Read the desired family code

◆ **Standard Code 39**



**Full ASCII Code 39**



② Read a check digit selection

### CHECK DIGIT TABLE

◆ no check digit control



check digit control  
and transmission



check digit control  
without transmission





## CODE SELECTION

---

The pharmaceutical codes below are part of the Code 39 family but have no check digit selections.

### Code CIP39



French pharmaceutical code

### Code 32



Italian pharmaceutical code

---

## CODE LENGTH (optional)

The code length selection is valid for the entire Code 39 family

Read the code + 4 numbers for the code length where:

**First 2 digits** = minimum code length.

**Second 2 digits** = maximum code length.

set code length



The maximum code length is **99** characters.

The minimum code length must always be less than or equal to the maximum.

Examples: **0199** = variable from 1 to 99 digits in the code. **1010** = 10 digit code length only.

**CODE SELECTION*****CODE 128 FAMILY***

disables the family



- ① Read the desired family code

**◆ Code 128**control without transmission  
of check digit**EAN 128**control without transmission  
of check digit**Transmit GS Before Code**

Code EAN 128 uses the ASCII <GS> character to separate a variable length code field from the next code field. This character can also be transmitted before the code.

**◆ disable****enable**

If the <GS> character has been modified in the Character Replacement parameter, the new character is affected by this command.





# CODE SELECTION

## ISBT 128



Enabling ISBT 128 automatically disables Puzzle Solver™.

## CODE LENGTH (optional)

The code length selection is valid for the entire Code 128 family.

Read the code + 4 numbers for the code length where:

set code length

**First 2 digits** = minimum code length



**Second 2 digits** = maximum code length

The maximum code length is 99 characters. The minimum code length must always be less than or equal to the maximum.

Examples: **0199** = variable from 1 to 99 digits in the code. **1010**= 10 digit code length only.

The length is calculated on the output string.

## CODE 93

◆ disables the code



### Code 93



control without transmission  
of check digit



# CODE SELECTION

## *CODABAR FAMILY*

◆ disables the family



① Read the desired equality control code

② Read a start/stop transmission selection

### Standard Codabar



no start/stop character equality control

### START/STOP CHARACTER TRANSMISSION

no transmission



### Standard Codabar



start/stop character equality control

transmission



The Codabar ABC code below uses a fixed start/stop character transmission selection.

### Codabar ABC



no start/stop character equality control but transmission.



## CODE SELECTION

---

### Codabar ABC Forced Concatenation

enable Codabar ABC with forced concatenation



non start/stop character equality control but transmission

---

### CODE LENGTH (optional)

The code length selection is valid for the entire Codabar family

Read the code + 4 numbers for the code length where:

**First 2 digits** = minimum code length.

**Second 2 digits** = maximum code length.

set code length



The maximum code length is **99** characters.

The minimum code length must always be less than or equal to the maximum.

Examples: **0199** = variable from 1 to 99 digits in the code. **1010** = 10 digit code length only.

---

### START/STOP CHARACTER CASE IN TRANSMISSION

The start/stop character case selections below are valid for the entire Codabar family:

transmit start/stop characters in lower case



transmit start/stop characters in upper case





# CODE SELECTION

## MSI

◆ disables the family



Enable the code by selecting one of the check digit selections.

no check digit control



MOD10 check digit control  
no check digit transmission



MOD10 check digit control  
check digit transmission



MOD11 - MOD10 check digit control  
no check digit transmission



MOD11 - MOD10 check digit control  
check digit transmission



MOD10 - MOD10 check digit control  
no check digit transmission



MOD10 - MOD10 check digit control  
check digit transmission





# CODE SELECTION

## *PLESSEY*

◆ disables the family



Enable the code by selecting one of the check digit selections.

### Standard Plessey

no check digit control



check digit control  
check digit transmitted



check digit control  
check digit not transmitted



### Anker Plessey

no check digit control



check digit control  
check digit transmitted



check digit control  
check digit not transmitted





# CODE SELECTION

## *TELEPEN*

◆ disables the family



Enable the code by selecting one of the check digit selections.

### **Numeric Telepen**

no check digit control



check digit control  
check digit transmitted



check digit control  
check digit not transmitted



### **Alphanumeric Telepen**

no check digit control



check digit control  
check digit transmitted



check digit control  
check digit not transmitted





# CODE SELECTION



---

## *DELTA IBM*

◆ disables the family



Enable the code by selecting one of the check digit selections.

no check digit control



Type 1 check digit control



Type 2 check digit control





# CODE SELECTION

## CODE 11

◆ disables the family



Enable the code by selecting one of the check digit selections.

no check digit control



Type C check digit control  
check digit transmitted



Type C check digit control  
check digit not transmitted



Type K check digit control  
check digit transmitted



Type K check digit control  
check digit not transmitted



Type C and Type K  
check digit control  
check digits transmitted



Type C and Type K  
check digit control  
check digits not transmitted





**CODE SELECTION**

---

***CODE 16K***

◆ disables the code

**Code 16K**

To read stacked codes, simply move the reader over the code so that each line of the code is scanned.

---

***CODE 49***

◆ disables the code

**Code 49**

To read stacked codes, simply move the reader over the code so that each line of the code is scanned.



# CODE SELECTION

## *RSS CODES*

◆ disables the family



### DISABLE CODE

disable RSS Expanded Linear and Stacked



disable RSS Limited



disable RSS 14 Linear and Stacked



### ENABLE CODE

enable RSS Expanded Linear and Stacked



enable RSS Limited



enable RSS 14 Linear and Stacked



To read the stacked version of these codes, simply move the reader over the code so that each line of the code is scanned.



# ADVANCED FORMATTING

- |                       |                            |                       |
|-----------------------|----------------------------|-----------------------|
| <input type="radio"/> | <b>CONCATENATION</b>       | <input type="radio"/> |
| <input type="radio"/> | <b>ADVANCED FORMATTING</b> | <input type="radio"/> |



NOTE

*Please follow the setup procedure carefully for these parameters.*

1. Read the **Enter Configuration** code ONCE, available at the top of page .
2. Read configuration codes precisely following the numbered procedure given.
  - = Read the code and follow the procedure given
  - ◆ = Default value
3. Read the **Exit and Save Configuration** code ONCE, available at the top of page.

---

## CONCATENATION

◆ disable



enable



Permits the concatenation of two codes defined by code type and length. It is possible to set a timeout for the second code reading and to define code transmission if the timeout expires.

**The order of transmission is CODE 1-CODE 2.**

### Define Concatenation

---

1

Code 1

code ID



Read the code type from the Code Identifier Table beginning in Appendix B.

code length



Read a number in the range **01-99** from the Hex/Numeric Table.

## ADVANCED FORMATTING



2

### Code 2

code ID



Read the code type from the Code Identifier Table beginning in Appendix B.

code length



Read a number in the range **01-99** from the Hex/Numeric Table.

3

### Concatenation Result Code ID

use code 1 ID



use code 2 ID



Since you can concatenate codes from different families, you must select the Code ID character of the resulting code. The Code ID character will be sent in the output message only if it is enabled according to the Code Identifier selection (Datalogic, AIM, or Custom).

4

### Concatenation Timeout

timeout



Read two numbers in the range **00 to 99**

00= no timeout

01-99 = timeout from 1 to 99 seconds

## ADVANCED FORMATTING



Define the timeout, which determines the valid waiting period between the two codes, in order to accept concatenation. If the timeout expires, the resulting action will be based on the following selection.

---

5

### Transmission after Timeout

no code transmitted  
after timeout



only code 1 transmitted  
(if read) after timeout



only code 2 transmitted  
(if read) after timeout



either code 1 or code 2 transmitted  
after timeout



# ADVANCED FORMATTING

## *ADVANCED FORMATTING*

Advanced formatting has been designed to offer you complete flexibility in changing the format of barcode data **before** transmitting it to the host system. This formatting will be performed when the barcode data meets certain criteria which you will define in the following procedure.

Up to 4 advanced code management formats can be defined and saved in memory. For each format you must complete the entire configuration procedure:

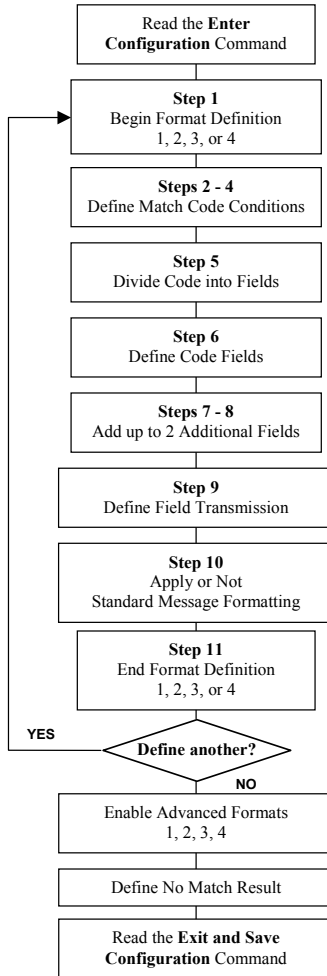

---

1

**Begin Format Definition**

begin Format 1 definition



begin Format 2 definition



begin Format 3 definition



begin Format 4 definition



---

2

**Match Code Type**

match code type



Read the above code + the code type to match from the Code Identifier Table in Appendix B.

**OR**

any code type



---

3

**Match Code Length**

match code length



Read the above code + two numbers in the range **01 to 99** for the exact code length.



Enter Configuration



OR

## ADVANCED FORMATTING

any code length



Exit and Save Configuration



# ADVANCED FORMATTING



4

## Match with Predefined Characters

no match



OR

match with 1 character



match with a 2-character string



match with a 3-character string



match with a 4-character string



After selecting the predefined match code, read the character(s) from the HEX table. Range of characters = **01-FE**.

### Example:

Match code with the 2-character predefined string = "@@".

Read  + 40 + 40

AND

position of first character in predefined string



## ADVANCED FORMATTING



Read the above code + two numbers in the range **01** to **99** representing the character position in the code where the first character of the predefined string must be found.

Read **00** if the match string can be found in any character position.

5

### Divide Code into Fields

divide code into fields



Read one number in the range **1** to **5** to divide the code into fields.

6

### Define Code Fields

define code fields

Each code field length can be set by either:

- a) defining a field separator character to be found in the code itself. In this case you can choose to **discard** the code separator character or **include** it as the last character of the field.

**OR BY**

- b) defining a match character to be found consecutively repeated in the code itself. In this case the field ends with the first character that does not match.

**OR BY**

- c) specifying a specific character length up to the maximum of 99 characters.

**OR BY**

- d) selecting the last field as variable length (if any).

**You must define the same number of fields as selected in step 5, including fields that will not be transmitted.**

# ADVANCED FORMATTING

Exit and Save Configuration



# ADVANCED FORMATTING



## DEFINE FIELD 1 BY: EITHER

a)

field separator

Read the field separator character from the HEX table. Range of characters = **01-FE**.

discard separator



include separator



OR

b)

match character

Read the match character from the HEX table. Range of characters = **01-FE**.

OR

c)

field length

Read two numbers in the range **01** to **99** to define the field length.

OR

d)

this is the last field (variable length)



AND

## Field 1 Terminators

no field terminators



1 field terminator



2 field terminators



Read the field terminator character(s) from the HEX table.

Valid range of characters for all readers = **01-FE**.

**ADVANCED FORMATTING**

For readers using Wedge interface, all values from **9C** to **FE** send the Space character.

**DEFINE FIELD 2 BY:  
EITHER**

field separator



a)

Read the field separator character from the HEX table. Range of characters = **01-FE**.

discard separator



include separator



**OR**

match character



b)

Read the match character from the HEX table. Range of characters = **01-FE**.

**OR**

field length



c)

Read two numbers in the range **01** to **99** to define the field length.

**OR**

this is the last field (variable length)



d)

**AND**

**Field 2 Terminators**

no field terminators



1 field terminator



2 field terminators



Read the field terminator character(s) from the HEX table.

**ADVANCED FORMATTING**

Valid range of characters for all readers = **01-FE**.

For readers using Wedge interface, all values from **9C** to **FE** send the Space character.

**DEFINE FIELD 3 BY:  
EITHER**

a)

field separator

Read the field separator character from the HEX table. Range of characters = **01-FE**.

discard separator  
include separator

**OR**

b)

match character

Read the match character from the HEX table. Range of characters = **01-FE**.

**OR**

c)

field length

Read two numbers in the range **01** to **99** to define the field length.

**OR**

d)

this is the last field (variable length)

**AND**

**Field 3 Terminators**

no field terminators



1 field terminator



2 field terminators



**ADVANCED FORMATTING**

Read the field terminator character(s) from the HEX table.

Valid range of characters for all readers = **01-FE**.

For readers using Wedge interface, all values from **9C** to **FE** send the Space character.

**DEFINE FIELD 4 BY:  
EITHER**

field separator



**a)**

Read the field separator character from the HEX table. Range of characters = **01-FE**.

discard separator



include separator



**OR**

match character



**b)**

Read the match character from the HEX table. Range of characters = **01-FE**.

**OR**

field length



**c)**

Read two numbers in the range **01** to **99** to define the field length.

**OR**

this is the last field (variable length)



**d)**

**AND**

**Field 4 Terminators**

no field terminators



1 field terminator

2 field terminators



# ADVANCED FORMATTING



Read the field terminator character(s) from the HEX table.

Valid range of characters for all readers = **01-FE**.

For readers using Wedge interface, all values from **9C** to **FE** send the Space character.

## DEFINE FIELD 5 BY: EITHER

a)

field separator



Read the field separator character from the HEX table. Range of characters = **01-FE**.

discard separator



include separator



OR

b)

match character



Read the match character from the HEX table. Range of characters = **01-FE**.

OR

c)

field length



Read two numbers in the range **01** to **99** to define the field length.

OR

d)

this is the last field (variable length)



AND

## Field 5 Terminators

no field terminators



# ADVANCED FORMATTING

Exit and Save Configuration



1 field terminator



2 field terminators



Read the field terminator character(s) from the HEX table.

Valid range of characters for all readers = **01-FE**.

For readers using Wedge interface, all values from **9C** to **FE** send the Space character.

---

7

## First Additional Fixed Field

no fixed field



1 character fixed field



2 character fixed field



3 character fixed field



4 character fixed field



5 character fixed field



# ADVANCED FORMATTING



6 character fixed field



After selecting **one** of the Additional Fixed Field codes, read the corresponding character(s) from the HEX table. Range of characters = **01-FE**. For readers using Wedge interface, all values from **9C** to **FE** send the Space character.

**Example:**

4 Character Fixed Field



+ 4D + 41 + 49 + 4E = MAIN

**8**

## Second Additional Fixed Field

no fixed field



1 character fixed field



2 character fixed field



3 character fixed field



4 character fixed field



## ADVANCED FORMATTING



5 character fixed field



6 character fixed field



After selecting **one** of the Additional Fixed Field codes, read the corresponding character(s) from the HEX table. Range of characters = **01-FE**. For readers using Wedge interface, all values from **9C** to **FE** send the Space character.

### Example:

3 Character Fixed Field



+ 53 + 45 + 54 = SET

9

### Field Transmission

number of fields to transmit



Read one number in the range **1** to **7** for the number of fields to transmit. **Include only fields to be transmitted.**

### Field Order Transmission

Read the codes corresponding to the fields to transmit in the order in which they are to be transmitted. A field can be transmitted more than once. See example.

field 1



field 2



field 3



field 4



field 5

# ADVANCED FORMATTING

Exit and Save Configuration



additional field 2



additional field 1



## Example:

The barcode is divided into 3 defined fields plus 1 additional fixed field.

Transmit in the order: Field 2, Additional Field 1, Field 1, Field 2.

Number of Fields



---

10

## Standard Formatting

do not apply standard formatting



apply standard formatting



After performing Advanced Formatting on the barcode read, Standard Formatting (Headers, Code Length, Code ID, Terminators) can be applied to the message to be transmitted.

---

11

## End Format Definition

end Format 1 definition





## ADVANCED FORMATTING

end Format 2 definition



end Format 3 definition



end Format 4 definition





# ADVANCED FORMATTING

## Enable Advanced Format

◆ no Advanced Formats enabled



enable



### Advanced Format 1

disable



enable



### Advanced Format 2

disable



enable



### Advanced Format 3

disable



enable



### Advanced Format 4

disable





## ADVANCED FORMATTING



---

### No Match Result

clear data - no transmission



transmit data using standard format



This selection determines the action to be taken when codes read do not conform to the advanced format requisites (no match).

- Codes not matching can be ignored, cleared from memory and not transmitted.
- Codes not matching can be transmitted using the Standard formatting (Headers, Code Length, Code ID, Terminators).



## 4 REFERENCES

### 4.1 USB-COM AND RS232 PARAMETERS

#### 4.1.1 Handshaking

Hardware handshaking: (RTS/CTS)

The RTS line is activated by the decoder before transmitting a character. Transmission is possible only if the CTS line (controlled by the Host) is active.

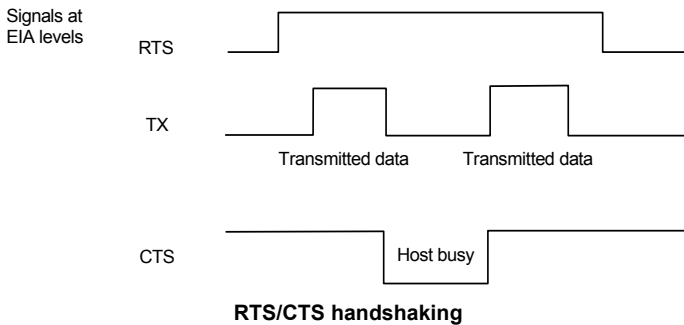

Software handshaking: (XON/XOFF)

During transmission, if the Host sends the XOFF character (13 Hex), the decoder interrupts the transmission with a maximum delay of one character and only resumes when the XON character (11 Hex) is received.

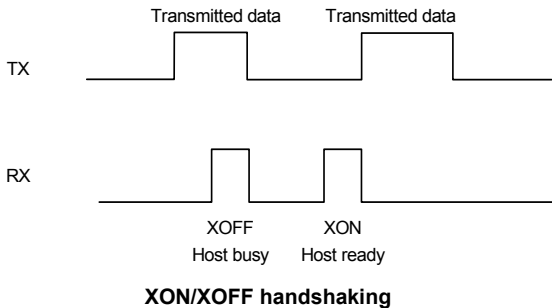

### **4.1.2 ACK/NACK Protocol**

This parameter sets a transmission protocol in which the Host responds to the reader after every code transmitted. The Host sends an ACK character (06 HEX) in the case of good reception or the NACK character (15 HEX) requesting re-transmission, in the case of bad reception.

If the reader does not receive an ACK or NACK, transmission is ended after the RX Timeout (see par. 4.1.4).

Selection of the ACK/NACK protocol automatically disables FIFO buffering see par. 4.1.3.

### **4.1.3 FIFO**

This parameter determines whether data (barcodes) are buffered on a First In First Out basis allowing faster data collection in certain cases for example when using slow baud rates and/or hardware handshaking.

If the FIFO buffering is enabled, codes are collected and sent out on the serial line in the order of acquisition. Several hundred characters can be collected (buffer full), after which the reader signals an error and discards any further codes until the transmission is restored.

If the FIFO buffering is disabled, each code must be transmitted before another one can be read.

### **4.1.4 RX Timeout**

When the RS232 interface is selected, the Host can be used to configure the device by sending it command strings (see appendix A).

This parameter can be used to automatically end data reception from the Host after the specified period of time.

If no character is received from the Host, after the timeout expires, any incomplete string (any string not terminated by <CR>) is flushed from the device buffer.

## 4.2 PEN PARAMETERS

### 4.2.1 Minimum Output Pulse

This parameter sets the duration of the output pulse corresponding to the narrowest element in the barcode. In this way the code resolution is controlled by the signal sent to the decoder, independently of the physical resolution of the code read.

The shortest pulse (200  $\mu$ s) corresponds to high-resolution code emulation and therefore a shorter transfer speed to the decoder (for decoders able to work on high-resolution codes). Likewise, longer pulses correspond to low-resolution code emulation and therefore a longer transfer time to the decoder.

### 4.2.2 Conversion to Code 39

When using these readers it is possible to convert all codes to Code 39. By disabling this option the decoded codes will be transmitted in their original format; except for the following codes which are ALWAYS converted into Code 39 format: MSI, Plessey, Telepen, Delta IBM, Code 11, Code 16K, Code 49 and RSS Codes.

### 4.2.3 Overflow

This parameter generates a white space before the first bar and after the last bar of the code. The selections are as follows:

narrow = space 10 times the minimum output pulse.  
medium = space 20 times the minimum output pulse.  
wide = space 30 times the minimum output pulse.

### 4.2.4 Output and Idle Levels

The following state diagrams describe the different output and idle level combinations for Pen emulation:

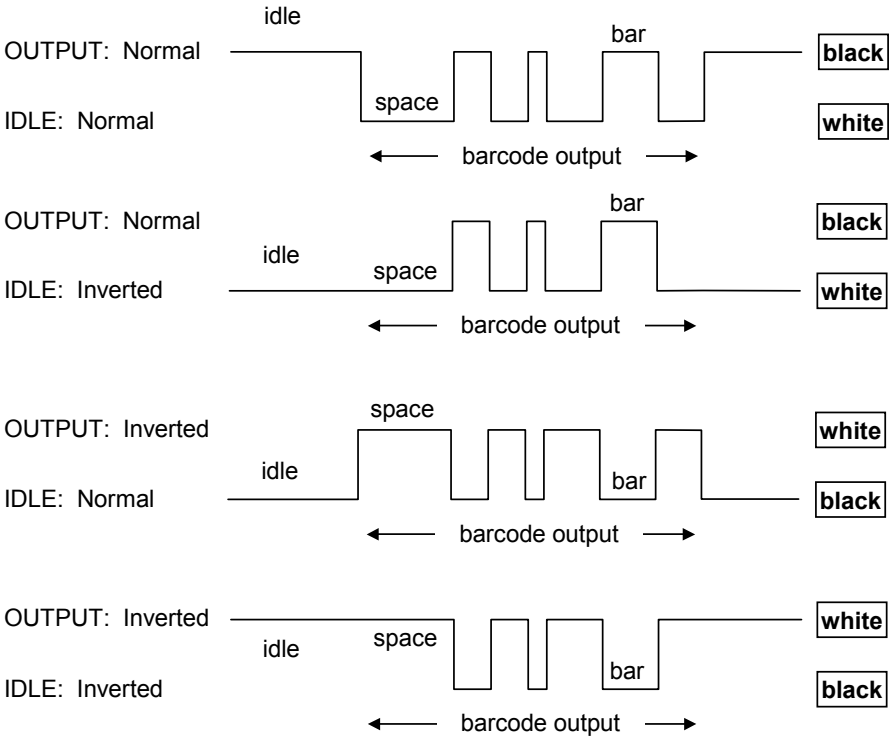

Output and Idle Levels

### 4.2.5 Inter-Block Delay

For the PEN Emulation interface, data are sent to the Host in fixed size blocks of 20 characters each. The inter-block delay parameter allows setting a delay between each block sent to the Host.

## 4.3 IBM 46XX

### 4.3.1 IBM Data Formatting (Transmission Format)

The IBM 46xx Series cash register recognizes the following codes:

- EAN 8 / EAN13 / UPC A / UPC E with and without Add On
- Interleaved 2/5
- Code 39
- Codabar
- Code 128
- Code 93
- Normal 2/5

The transmission format of codes belonging to this set is specified by the protocol. As the reader allows a wider set of codes to be selected, the following formats are defined to offer the user all the reading possibilities of the Datalogic product.

#### **Conversion to Code 39 Format**

Data from any code selected may be transmitted. Each code is transmitted to the Host as Code 39. Any character not included in the standard Code 39 set will be replaced with a "Space" (20 Hex).

#### **IBM Standard Format**

Only codes belonging to the above mentioned set may be transmitted. Each code transmitted to the Host is recognized by the identifier requested by the protocol. If the selected code does not belong to this set, it will not be transmitted.

#### **Mixed IBM Standard + Code 39 Format**

Data from any code selected may be transmitted. For codes belonging to the above mentioned set, the "IBM Standard Format" is applied. The "Code 39" Format applies to codes not belonging to this set.

## 4.4 DATA FORMAT

### 4.4.1 Header/Terminator Selection

The header/terminator selection is not effected by the reading of the restore default code. In fact, header and terminator default values depend on the interface selection:

RS232 and USB-COM: no header, terminator CR-LF  
 WEDGE and USB-KBD: no header, terminator ENTER  
 WEDGE ALT-MODE and USB-KBD-ALT-MODE: no header, terminator CR

These default values are always restored through the reading of the relative interface selection code, see chapter 2.

For the WEDGE interface, the following extended keyboard values can also be configured:

| EXTENDED KEYBOARD TO HEX CONVERSION TABLE |                                 |              |                               |                 |
|---|---------------------------------|--------------|-------------------------------|-----------------|
| HEX                                       | IBM AT<br>IBM 3153<br>APPLE ADB | IBM XT       | IBM 31xx, 32xx,<br>34xx, 37xx | Wyse<br>Digital |
| 83  | ENTER                           | ENTER        | FIELD EXIT                    | RETURN          |
| 84  | TAB                             | TAB          | TAB                           | TAB             |
| 85  | F1                              | F1           | F1                            | F1              |
| 86  | F2                              | F2           | F2                            | F2              |
| 87  | F3                              | F3           | F3                            | F3              |
| 88  | F4                              | F4           | F4                            | F4              |
| 89  | F5                              | F5           | F5                            | F5              |
| 8A  | F6                              | F6           | F6                            | F6              |
| 8B  | F7                              | F7           | F7                            | F7              |
| 8C  | F8                              | F8           | F8                            | F8              |
| 8D  | F9                              | F9           | F9                            | F9              |
| 8E  | F10                             | F10          | F10                           | F10             |
| 8F  | F11                             | ESC          | F11                           | F11             |
| 90  | F12                             | BACKSPACE    | F12                           | F12             |
| 91  | HOME                            | HOME         | ENTER                         | F13             |
| 92  | END                             | END          | RESET                         | F14             |
| 93  | PG UP                           | PG UP        | INSERT                        | F15             |
| 94  | PG DOWN                         | PG DOWN      | DELETE                        | F16             |
| 95  | ↑                               | ↑            | FIELD -                       | UP              |
| 96  | ↓                               | ↓            | FIELD +                       | DOWN            |
| 97  | ←                               | ←            | ENTER (Paddle)                | LEFT            |
| 98  | →                               | →            | PRINT                         | RIGHT           |
| 99  | ESC                             | ESC          |                               | ESC             |
| 9A  | CTRL (Right)                    | CTRL (Right) |                               | CTRL (Right)    |
| 9B  | Euro                            | Space        | Space                         | Space           |

For all readers using Wedge interface, all values from **9C** to **FE** send the Space character.

#### 4.4.2 Set Custom Extended Header/Terminator Keys

The extended Header/Terminator keys for **Wedge Interface users** can be customized by defining them through a simple keyboard setting procedure.

For example, the Numeric Keypad keys can be set for use as Headers or Terminators by substituting the default extended keys using this procedure.

The type of computer or terminal must be selected before activating the keyboard setting command.

Press and release a key to set it.

Some characters may require more than one key pressed simultaneously during normal use (refer to the manual of your PC or terminal for keyboard use). The exact sequence must be indicated to the reader in this case pressing and releasing the different keys.

##### **Example:**

If one has to press the "Shift" and "4" keys simultaneously on the keyboard to transmit the character "\$" to the video, to set the "\$", press and release "Shift" then press and release "4".

Each pressed and released key must generate an acoustic signal on the reader, otherwise repress the key. Never press more than one key at the same time, even if this corresponds to the normal use of your keyboard.

**Press "Backspace" to correct a wrong key entry. In this case the reader emits 2 beeps.**

**Note: "CAPS LOCK" and "NUM LOCK" must be off before starting the keyboard setting procedure. "SHIFT" must be repressed for each character and cannot be substituted by "CAPS LOCK".**



## Set Custom Extended Header/Terminator Keys



Read the code above.

- If the first 4 KEYS (Shift, Alt, Ctrl, and Backspace) are not available on your keyboard, you can only substitute them with keys not used, or substitute them with each other.
- Keys 5 to 28 must be defined

Press the desired keys in the following order:

**The reader signals the end of the procedure with 2 beeps indicating the keys have been registered.**

| CUSTOM EXTENDED KEYBOARD SETTING TABLE |     |           |
|--|-----|-----------|
|  |     | Custom    |
| Order                                  | HEX | KEY       |
| 01                                     | -   | Shift     |
| 02                                     | -   | Alt       |
| 03                                     | -   | Ctrl      |
| 04                                     | -   | Backspace |
| 05                                     | 83  |           |
| 06                                     | 84  |           |
| 07                                     | 85  |           |
| 08                                     | 86  |           |
| 09                                     | 87  |           |
| 10                                     | 88  |           |
| 11                                     | 89  |           |
| 12                                     | 8A  |           |
| 13                                     | 8B  |           |
| 14                                     | 8C  |           |
| 15                                     | 8D  |           |
| 16                                     | 8E  |           |
| 17                                     | 8F  |           |
| 18                                     | 90  |           |
| 19                                     | 91  |           |
| 20                                     | 92  |           |
| 21                                     | 93  |           |
| 22                                     | 94  |           |
| 23                                     | 95  |           |
| 24                                     | 96  |           |
| 25                                     | 97  |           |
| 26                                     | 98  |           |
| 27                                     | 99  |           |
| 28                                     | 9A  |           |



## 4.5 POWER SAVE

### 4.5.1 Sleep State/USB Suspend

When using standard devices, this mode allows the  $\mu$ P in the reader to enter a "Sleep" state for minimum power consumption. This command is only valid when hardware trigger type is selected.

Before entering Sleep mode, the following are verified:

- no commands coming from Host
- no data being transmitted to Host
- Enter Sleep Timeout ended (see par. 4.5.2)

It is possible to exit Sleep mode either by pressing the button/trigger or by inserting the reader into the Stand (only for devices with Stand Recognition Beep).

Enabling the Sleep State/USB Suspend implements Standby mode for CCD devices, see par. 4.5.3.

When using USB devices, this mode allows the device to manage Selective Suspend conditions generated by the Host Operating System in which optimizing low power consumption (ex. Windows Stand-by). It is possible to exit the Suspend mode either from the Host (ex. moving the mouse during Stand-by) or through the barcode reader. The latter, called Remote Wakeup, makes the device wake up the Host restoring the communication. Remote Wakeup is possible either by pressing the button/trigger or by putting the reader into the stand (only for devices with Stand Recognition Beep).

### 4.5.2 Enter Sleep Timeout

For readers that have the Sleep state enabled, this timeout determines when the reader will enter this state.

### 4.5.3 Standby (*only for CCD devices*)

If this command is enabled, part of the CCD circuitry shuts down (Standby), in order to optimize low power consumption when not reading. When the trigger is pressed this circuitry powers up. This mode causes a minor delay before the reader is ready.

## 4.6 READING PARAMETERS

### 4.6.1 Hand-Held and Stand Operation

These parameter groups allow setting different reading modes for Hand-Held Operation and Stand Operation:

- **Software Trigger:** the reader is set in FLASH MODE. Code reading takes place during the *flash on* time;
- **Hardware Trigger:** the code reading is started with a trigger press (ON);
- **Hardware Trigger Ready:** the illuminator is switched ON when the reader sees a code. It functions as a pointer aiming at the code to be read. The reading phase starts only when the trigger is pressed. In this mode the reader is automatically set to **trigger active level** and **one read per cycle** parameters. (Only for Hand-Held Operation).
- **Automatic:** the illuminator is switched ON when the reader sees a code. The reading phase starts automatically.
- **Always ON:** the illuminator/laser is always ON and the reader always ready for code reading.

### 4.6.2 Hardware Trigger Signal

This parameter determines how the reader ON state is controlled for readers with button/trigger when *Hardware Trigger* is selected:

- **trigger level:** the reader goes ON when the trigger is pressed and goes OFF when it is released
- **trigger pulse:** the reader goes ON at the first trigger press and goes OFF only at a second press

### 4.6.3 Trigger-Off Timeout

When this timeout is selected, the reader turns OFF automatically after the desired period of time.

### 4.6.4 Reads per Cycle

In general, a **reading cycle** corresponds to the ON + OFF times of a device. The resulting effects of this parameter on code reading depend on other related configuration conditions. Here are the definitions of ON and OFF times.

- For readers using the software trigger parameter (FLASH MODE), a reading cycle corresponds to the flash on + flash off times. Code reading takes place during the flash on time.
- For readers using the hardware trigger parameter, a reading cycle corresponds to a trigger press (ON) + one of the following OFF events:
  - trigger release (for *trigger active level*)
  - a second trigger press (for *trigger active pulse*)
  - trigger-off timeout* (see par. 4.6.3).

When **one read per cycle** is selected, the device decodes only one code during the ON period and immediately turns the reader OFF. It is only possible to read another code when the next ON time occurs.

In **multiple reads per cycle**, the ON period is extended so that the device can continue decoding codes until an OFF event occurs. For software trigger mode, the *flash on* period is immediately reset after each read and therefore extended. If another code is decoded before the reset *flash on* period expires, it is again reset and the effect is that the device remains ON, decoding codes until the *flash on* or *timeout* period expires.

The Safety Time parameter should be used in this case to avoid unwanted multiple reading of the same code, see par. 4.6.5.

### 4.6.5 Safety Time

Safety time prevents the device from immediately decoding the same code more than once. Same code consecutive reading can be disabled requiring the reader to be removed from the code (no decoding) for at least 400 ms, or a timeout can be set up to 9.9 seconds before the decoder will accept the same code. Reading is immediate if the code changes.

For *Automatic* Hand-Held or Stand Operation, the Safety Time parameter is forced to no code consecutive reading (00).

The safety time parameter is not applicable when reading stacked codes or when setting one read per cycle in hardware trigger operating mode, since these settings require voluntary action by the user.

### 4.6.6 Automatic Operation Aiming Light

This parameter is valid for CCD long range devices in *Automatic* Hand-Held or Stand Operation and allows an aiming light to be continuously emitted in front of the reader to facilitate the positioning of the barcode to be read.

## 4.6.7 Aiming System

This parameter is valid for laser readers and provides a programmable timeout for the aiming system. If enabled, the scan line emitted from the reading window is preceded by a red spot which must illuminate the code center to get the best reading performance (see figure, ①). Once the defined timeout is reached, the red spot disappears and is followed by the scan line to start the code scanning.

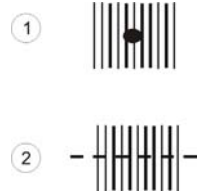

## 4.7 DECODING PARAMETERS



**CAUTION**

*These parameters are intended to enhance the decoding capability of the reader for particular applications. Used incorrectly, they can degrade the reading performance or increase the possibility of a decoding error.*

### 4.7.1 Ink-Spread

The ink-spread parameter allows the decoding of codes which are not perfectly printed because the page texture tends to absorb the ink.

### 4.7.2 Overflow Control

The overflow control parameter can be disabled when decoding codes printed on small surfaces, which don't allow the use of an overflow space.

This command does not effect code families 2/5, Code 128 and Code 93.



### 4.7.3 Interdigit Control

The interdigit control parameter verifies the interdigit spacing for code families Code 39 and Codabar.

---

## 4.8 CONFIGURATION EDITING COMMANDS

The following commands carry out their specific function and then exit the configuration environment.

| Command   | Description  |
|---|--|
|  | Restore system default configuration (see the relative Quick Reference Manual for default settings)                |
|  | Transmit the Software release. This command is not effective with the Pen emulation interface.                     |
|  | Transmit the device configuration in ASCII format. This command is not effective with the Pen emulation interface. |

---

## 4.9 CONFIGURATION COPY COMMAND

### **Procedure:**

- ① Connect the **master** (correctly configured reader) and the **slave** (reader to be configured) together through two RS232 serial interface cables and external power supply. Accessory cables and power supply are available from your Datalogic distributor to provide this connection.

RS232 Cables: CAB363 & CAB364 or CAB320 & CAB328

Power Supply: PG5

- ② Using the slave device, read the Restore Default barcode and then the RS232 interface barcode from par. 2.1.2 of this manual or from the Quick Reference Manual.
- ③ With the master device, read the Configuration Copy barcode below.

### **Copy Configuration**



The configuration will be copied from the master to the slave device. The slave device signals the end of the procedure with a series of beeps.

**Note:** The master device can be configured for any interface.

## 4.10 DEFAULT PARAMETERS FOR POS SYSTEMS

The default values for the RS232 and Data Format parameters for POS systems are listed in the following table:

|                          | <b>NIXDORF Mode A</b> | <b>FUJITSU</b>  | <b>ICL Mode</b> |
|--------------------------|-----------------------|-----------------|-----------------|
| <b>RS232 Group</b>       |                       |                 |                 |
| Baud Rate                | 9600                  | 9600            | 9600            |
| Parity                   | Odd                   | None            | Even            |
| Data Bits                | 8                     | 8               | 8               |
| Stop Bits                | 1                     | 1               | 1               |
| Handshaking              | Hardware (RTS/CTS)    | None            | RTS always on   |
| ACK/NACK Protocol        | Disabled              | Disabled        | Disabled        |
| FIFO                     | Disabled              | Enabled         | Enabled         |
| Inter-Character Delay    | Disabled              | Disabled        | Disabled        |
| RX Timeout               | 9.9 sec               | 2 sec           | 9.9 sec         |
| Serial Trigger Lock      | Disabled              | Disabled        | Disabled        |
| <b>Data Format Group</b> |                       |                 |                 |
| Code Identifier          | Custom                | Custom          | Custom          |
| Header                   | No Header             | No Header       | No Header       |
| Terminator               | CR                    | CR              | CR              |
| Field Adjustment         | Disabled              | Disabled        | Disabled        |
| Code Length TX           | Not Transmitted       | Not Transmitted | Not Transmitted |
| Character Replacement    | Disabled              | Disabled        | Disabled        |

The table below lists all the Code Identifiers available for POS systems:

| <b>CODE</b>        | <b>NIXDORF Mode A</b> | <b>FUJITSU</b> | <b>ICL Mode</b> |
|--------------------|-----------------------|----------------|-----------------|
| UPC-A              | A0                    | A              | A               |
| UPC-E              | C0                    | E              | E               |
| EAN-8              | B                     | FF             | FF              |
| EAN-13             | A                     | F              | F               |
| Code 39            | M                     | None           | C [code length] |
| Codabar            | N                     | None           | N [code length] |
| Code 128           | K                     | None           | L [code length] |
| Interleaved 2 of 5 | I                     | None           | I [code length] |
| Code 93            | L                     | None           | None            |
| Industrial 2 of 5  | H                     | None           | H [code length] |
| UCC/EAN 128        | P                     | None           | L [code length] |
| MSI/Plessey        | O                     | None           | None            |
| Code 11            | None                  | None           | None            |

## 4.11 FIRMWARE UPGRADES

Device firmware upgrades can be performed using the DL Sm@rtSet external Downloader utility tool from your PC either through RS232 or USB communications. The procedure for downloading is described in the DL Sm@rtSet User's Manual and in the Help window.

A special case occurs when using USB communications to upgrade devices without button/trigger.

**Procedure:                      For devices WITHOUT button/trigger**

- ① Launch the Downloader tool from the DL Sm@rtSet folder on your PC.
- ② Connect the device to the PC via USB interface.
- ③ Read the code given below to emulate the trigger press:

**Trigger Press**



The device will automatically be reset.

- ④ Proceed with the firmware upgrade (see the DL Sm@rtSet User's Manual for details).



## A HOST CONFIGURATION STRINGS

In this section we provide a description of how to modify the device configuration using serial strings sent from the Host.

**This method requires either the RS232 or USB-COM interface.**

The device configuration can be changed by receiving commands from the Host through the serial interface. When this method is used, the programming sequence format is the following:

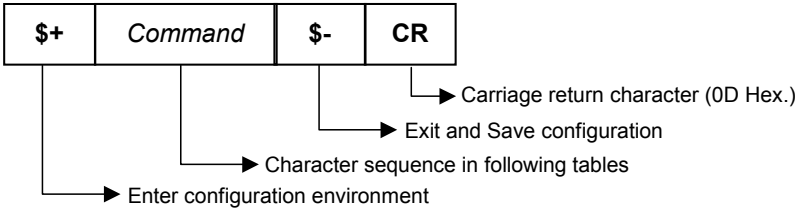

**Example:**

Multiple command programming sequence:

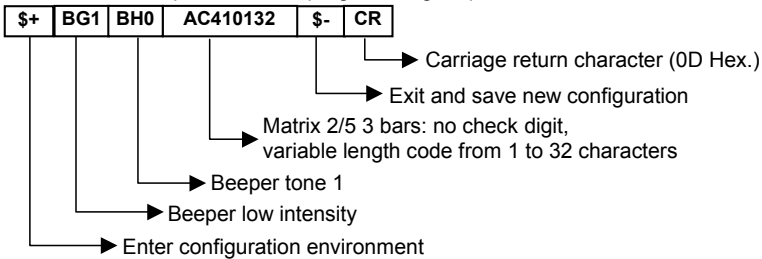

Each configuration parameter setting removes the condition previously active for that parameter.



**NOTE**

*The device buffer can contain about 400 characters. If your programming string goes over this value, you must split it into separate groups and send each group after a delay of at least 3 seconds to give the reader time to empty the buffer and interpret the commands.*

**SERIAL CONFIGURATION STRINGS**

| <b>ENTER/EXIT CONFIGURATION COMMANDS</b>          |               |
|---|---------------|
| <b>DESCRIPTION</b>                                | <b>STRING</b> |
| Enter Configuration                               | \$+           |
| Exit and Save Configuration                       | \$-           |
| Restore Default                                   | \$\$*         |
| Transmit Software Release (not for PEN emulation) | \$\$!         |
| Transmit Configuration (not for PEN emulation)    | \$\$&         |

| <b>INTERFACE SELECTION</b>          |  |               |     |
|-------------------------------------|--|---------------|-----|
| <b>DESCRIPTION</b>                  |  | <b>STRING</b> |     |
| USB                                 | USB-KBD  | UA03          |     |
|                                     | USB-KBD-ALT-MODE   | UA04          |     |
|                                     | USB-KBD-APPLE  | UA05          |     |
|                                     | USB-COM  | UA02          |     |
|                                     | USB-IBM-Table Top  | UA00          |     |
|                                     | USB-IBM-Hand Held  | UA01          |     |
| RS232                               | Standard   | CP0           |     |
|                                     | ICL Mode   | CM0           |     |
|                                     | Fujitsu  | CM1           |     |
|                                     | Nixdorf Mode A   | CM2EC0        |     |
| WEDGE                               | for IBM AT   | CP500         |     |
|                                     | for IBM Terminals: 31xx, 32xx, 34xx, 37xx; make-break keyboard | CP501         |     |
|                                     | for IBM Terminals: 31xx, 32xx, 34xx, 37xx; make-only keyboard  | CP502         |     |
|                                     | Keyboard Type for IBM Terminals<br>31xx, 32xx, 34xx, 37xx      | typewriter    | FK0 |
|                                     |  | advanced      | FK1 |
|                                     | for IBM XT   | CP503         |     |
|                                     | for IBM Terminal 3153  | CP504         |     |
|                                     | for IBM PC Notebook  | CP505         |     |
|                                     | for IBM SURE1  | CP506         |     |
|                                     | for IBM AT - ALT mode  | CP507         |     |
|                                     | for IBM PC Notebook - ALT mode                                 | CP508         |     |
|                                     | for Wyse Terminal - ANSI Keyboard                              | CP509         |     |
|                                     | for Wyse Terminal - PC Keyboard                                | CP510         |     |
|                                     | for Wyse Terminal - ASCII Keyboard                             | CP511         |     |
|                                     | for Wyse Terminal - VT220 style Keyboard                       | CP514         |     |
| for Digital Terminals VT2xx/3xx/4xx | CP512  |               |     |
| for Apple ADB Bus                   | CP513  |               |     |
| PEN EMULATION                       |  | CP6           |     |
| IBM 46xx                            | 4501 Protocol  | CP800         |     |
|                                     | 1520 Protocol  | CP801         |     |

| USB  |                               |                           |
|--|-------------------------------|---------------------------|
| DESCRIPTION  |                               | STRING                    |
| <b>USB-COM</b>                                     |                               |                           |
| Handshaking  | disable                       | <b>CE0</b>                |
|  | RTS/CTS                       | <b>CE1</b>                |
|  | XON/XOFF                      | <b>CE2</b>                |
|  | RTS always ON                 | <b>CE3</b>                |
| ACK/NACK Protocol                                  | disable                       | <b>ER0</b>                |
|  | enable                        | <b>ER1</b>                |
| FIFO   | disable                       | <b>EC0</b>                |
|  | enable                        | <b>EC1</b>                |
| Inter-character delay ( <i>ms</i> )                |                               | <b>CK00 - CK99</b>        |
| RX Timeout ( <i>100 ms</i> )                       |                               | <b>CL00 - CL99</b>        |
| Serial Trigger Lock                                | disable                       | <b>CR0</b>                |
|  | enable                        | <b>CR1<math>ab</math></b> |
| <b>USB-KBD</b>                                     |                               |                           |
| Keyboard nationality<br>(not for USB-KBD-ALT-MODE) | Belgian                       | <b>FJ7</b>                |
|  | English                       | <b>FJ4</b>                |
|  | French                        | <b>FJ2</b>                |
|  | German                        | <b>FJ3</b>                |
|  | Italian                       | <b>FJ1</b>                |
|  | Spanish                       | <b>FJ6</b>                |
|  | Swedish                       | <b>FJ5</b>                |
|  | USA                           | <b>FJ0</b>                |
| FIFO   | disable                       | <b>EC0</b>                |
|  | enable                        | <b>EC1</b>                |
| Delays   | Inter-Character ( <i>ms</i> ) | <b>CK00 - CK99</b>        |
|  | Inter-Code ( <i>s</i> )       | <b>FG00 - FG99</b>        |
| Control Character Emulation                        | CTRL + Shift + Key            | <b>FO0</b>                |
|  | Ctrl + Key                    | <b>FO1</b>                |

**a** = Hex value of the ASCII character from **00** to **FE** enabling the device trigger;

**b** = Hex value of the ASCII character from **00** to **FE** disabling the device trigger;

| <b>RS232</b>               |               |                            |
|----------------------------|---------------|----------------------------|
| <b>DESCRIPTION</b>         |               | <b>STRING</b>              |
| Baud rate                  | 300           | <b>CD1</b>                 |
|                            | 600           | <b>CD2</b>                 |
|                            | 1200          | <b>CD3</b>                 |
|                            | 2400          | <b>CD4</b>                 |
|                            | 4800          | <b>CD5</b>                 |
|                            | 9600          | <b>CD6</b>                 |
|                            | 19200         | <b>CD7</b>                 |
|                            | 38400         | <b>CD8</b>                 |
| Parity                     | none          | <b>CC0</b>                 |
|                            | even          | <b>CC1</b>                 |
|                            | odd           | <b>CC2</b>                 |
| Data bits                  | 7             | <b>CA0</b>                 |
|                            | 8             | <b>CA1</b>                 |
|                            | 9             | <b>CA2</b>                 |
| Stop bits                  | 1             | <b>CB0</b>                 |
|                            | 2             | <b>CB1</b>                 |
| Handshaking                | disable       | <b>CE0</b>                 |
|                            | RTS/CTS       | <b>CE1</b>                 |
|                            | XON/XOFF      | <b>CE2</b>                 |
|                            | RTS always ON | <b>CE3</b>                 |
| ACK/NACK Protocol          | disable       | <b>ER0</b>                 |
|                            | enable        | <b>ER1</b>                 |
| FIFO                       | disable       | <b>EC0</b>                 |
|                            | enable        | <b>EC1</b>                 |
| Inter-character delay (ms) |               | <b>CK00 - CK99</b>         |
| RX Timeout (100 ms)        |               | <b>CL00 - CL99</b>         |
| Serial Trigger Lock        | disable       | <b>CR0</b>                 |
|                            | enable        | <b>CR1<i>a</i><i>b</i></b> |

**a** = Hex value of the ASCII character from **00** to **FE** enabling the device trigger;

**b** = Hex value of the ASCII character from **00** to **FE** disabling the device trigger;

| WEDGE  |                                   |             |
|--|-----------------------------------|-------------|
| DESCRIPTION  |                                   | STRING      |
| Keyboard nationality                                   | Belgian                           | FJ7         |
|  | English                           | FJ4         |
|  | French                            | FJ2         |
|  | German                            | FJ3         |
|  | Italian                           | FJ1         |
|  | Spanish                           | FJ6         |
|  | Swedish                           | FJ5         |
|  | USA                               | FJ0         |
| Caps Lock  | Japanese (IBM AT compatible only) | FJ8         |
|  | caps Lock ON                      | FE1         |
|  | caps Lock OFF                     | FE0         |
| Caps Lock Auto-Recognition<br>(IBM AT compatible only) | disable                           | FP0         |
|  | enable                            | FP1         |
| Num Lock   | Toggle Num Lock                   | FL1         |
|  | Num Lock Unchanged                | FL0         |
| Delays   | Inter-Character ( <i>ms</i> )     | CK00 - CK99 |
|  | Inter-Code ( <i>s</i> )           | FG00 - FG99 |
| Control Character Emulation                            | CTRL +Shift + Key                 | FO0         |
|  | Ctrl + Key                        | FO1         |

| PEN                        |   |           |
|----------------------------|---|-----------|
| DESCRIPTION                |   | STRING    |
| Operating mode             | interpret (does not require \$+ or \$-)   | \$]       |
|                            | transparent (does not require \$+ or \$-) | \$[       |
| Minimum output pulse       | 200 $\mu$ s                               | DG0       |
|                            | 400 $\mu$ s                               | DG1       |
|                            | 600 $\mu$ s                               | DG2       |
|                            | 800 $\mu$ s                               | DG3       |
|                            | 1 ms                                      | DG4       |
|                            | 1.2 ms                                    | DG5       |
| Conversion to Code 39      | disable conversion to Code 39             | DA0       |
|                            | enable conversion to Code 39              | DA1       |
| Output level               | normal                                    | DD0       |
|                            | inverted                                  | DD1       |
| Idle level                 | normal                                    | DE0       |
|                            | inverted                                  | DE1       |
| Overflow                   | narrow overflow                           | DH0       |
|                            | medium overflow                           | DH1       |
|                            | wide overflow                             | DH2       |
| Inter-Block Delay (100 ms) |   | CK00-CK99 |

| IBM 46xx            |                                     |        |
|---------------------|-------------------------------------|--------|
| DESCRIPTION         |                                     | STRING |
| IBM Data Formatting | Code 39 Format                      | GD0    |
|                     | IBM Standard Format                 | GD1    |
|                     | Mixed IBM Standard + Code 39 Format | GD2    |

| DATA FORMAT                             |                      |                     |
|---|----------------------|---------------------|
| <i>NOT FOR PEN EMULATION INTERFACES</i> |                      |                     |
| DESCRIPTION                             |                      | STRING              |
| Code Identifier                         | disable              | EB0                 |
|   | Datalogic standard   | EB1                 |
|   | AIM standard         | EB2                 |
|   | Custom               | EB3                 |
| Custom Code Identifier                  |                      | EH <i>abc</i>       |
| Headers                                 | no header            | EA00                |
|   | one character        | EA01 <i>x</i>       |
|   | two characters       | EA02 <i>xx</i>      |
|   | three characters     | EA03 <i>xxx</i>     |
|   | four characters      | EA04 <i>xxxx</i>    |
|   | five characters      | EA05 <i>xxxxx</i>   |
|   | six characters       | EA06 <i>xxxxxx</i>  |
|   | seven characters     | EA07 <i>xxxxxxx</i> |
| eight characters                        | EA08 <i>xxxxxxxx</i> |                     |
| Terminators                             | no terminator        | EA10                |
|   | one character        | EA11 <i>x</i>       |
|   | two characters       | EA12 <i>xx</i>      |
|   | three characters     | EA13 <i>xxx</i>     |
|   | four characters      | EA14 <i>xxxx</i>    |
|   | five characters      | EA15 <i>xxxxx</i>   |
|   | six characters       | EA16 <i>xxxxxx</i>  |
|   | seven characters     | EA17 <i>xxxxxxx</i> |
| eight characters                        | EA18 <i>xxxxxxxx</i> |                     |

*a* = ASCII character.  
*b, c, x* = HEX values representing an ASCII character.

*a* = ASCII character of the DATALOGIC STANDARD Code Identifier from the table on page 44.

*b* = Hex value of the first Custom Code Identifier character from **00** to **FE**;  
**FF** = disable Code Identifier

*c* = Hex value of the second Custom Code Identifier character from **00** to **FE**;  
**FF** = disable second character of Custom Code Identifier

*x* = Hex value from **00** to **FE**

| <b>DATA FORMAT (continued)</b>          |                               |               |
|---|-------------------------------|---------------|
| <b>NOT FOR PEN EMULATION INTERFACES</b> |                               |               |
| <b>DESCRIPTION</b>                      |                               | <b>STRING</b> |
| Code Length Tx                          | not transmitted               | <b>EE0</b>    |
|   | transmitted                   | <b>EE1</b>    |
|   | transmitted in 4-digit format | <b>EE2</b>    |
| Field Adjustment                        | disabled                      | <b>EF0</b>    |
|   | right addition                | <b>EFa0d</b>  |
|   | left addition                 | <b>EFa1d</b>  |
|   | right deletion                | <b>EFa2d</b>  |
|   | left deletion                 | <b>EFa3d</b>  |
| Field Adjustment Character              |                               | <b>EGe</b>    |
| Character Replacement                   | disable character replacement | <b>EO0</b>    |
|   | first character replacement   | <b>EO1afg</b> |
|   | second character replacement  | <b>EO2afg</b> |
|   | third character replacement   | <b>EO3afg</b> |

*a* = ASCII character.

*d* = a number from the Hex/Numeric Table.

*e, f, g* = HEX values representing an ASCII character.

*a* = ASCII character of the DATALOGIC STANDARD Code Identifier from the table on page 44.

*d* = a number in the range **01 – 32** from the Hex/Numeric Table

*e* = Hex value from **00 to FE**

*f* = Hex value of the character to be replaced from **00 to FE**

*g* = Hex value of the new character to insert from **00 to FE**

**FF** = replace with no new character (remove character)

| <b>POWER SAVE</b>                     |         |                  |
|---------------------------------------|---------|------------------|
| <b>DESCRIPTION</b>                    |         | <b>STRING</b>    |
| Scan Rate                             | Quarter | <b>BT0</b>       |
|                                       | Half    | <b>BT1</b>       |
|                                       | Maximum | <b>BT2</b>       |
| Sleep State/USB Suspend               | disable | <b>BQ0</b>       |
|                                       | enable  | <b>BQ1</b>       |
| Enter Sleep Timeout ( <i>100 ms</i> ) |         | <b>BR00-BR99</b> |
| Standby                               | enable  | <b>BM0</b>       |
|                                       | disable | <b>BM1</b>       |

| <b>READING PARAMETERS</b>        |                        |                      |
|----------------------------------|------------------------|----------------------|
| <b>DESCRIPTION</b>               |                        | <b>STRING</b>        |
| Hand-Held Operation              | software trigger       | <b>BK0</b>           |
|                                  | hardware trigger       | <b>BK1</b>           |
|                                  | automatic              | <b>BK2</b>           |
|                                  | always on              | <b>BK3</b>           |
|                                  | hardware trigger ready | <b>BK4</b>           |
| Stand Operation                  | software trigger       | <b>BU1</b>           |
|                                  | hardware trigger       | <b>BU3</b>           |
|                                  | automatic              | <b>BU0</b>           |
|                                  | always on              | <b>BU2</b>           |
| Hardware Trigger Signal          | trigger active level   | <b>BA0</b>           |
|                                  | trigger active pulse   | <b>BA1</b>           |
| Trigger-off Timeout (s)          |                        | <b>BD00 - BD99</b>   |
| FLASH ON (100 ms)                |                        | <b>BB001 - BB099</b> |
| FLASH OFF (100 ms)               |                        | <b>BB101 - BB199</b> |
| Reads per Cycle                  | one read               | <b>BC0</b>           |
|                                  | multiple reads         | <b>BC1</b>           |
| Safety Time (100 ms)             |                        | <b>BE00 - BE99</b>   |
| Beeper Intensity                 | beeper off             | <b>BG0</b>           |
|                                  | low intensity          | <b>BG1</b>           |
|                                  | medium intensity       | <b>BG2</b>           |
|                                  | high intensity         | <b>BG3</b>           |
| Beeper Tone                      | tone 1                 | <b>BH0</b>           |
|                                  | tone 2                 | <b>BH1</b>           |
|                                  | tone 3                 | <b>BH2</b>           |
|                                  | tone 4                 | <b>BH3</b>           |
| Beeper Type                      | monotone               | <b>BJ0</b>           |
|                                  | bitonal                | <b>BJ1</b>           |
| Beeper Length                    | long                   | <b>BI0</b>           |
|                                  | short                  | <b>BI1</b>           |
| Good Read Spot Duration          | disable                | <b>BV0</b>           |
|                                  | short                  | <b>BV1</b>           |
|                                  | medium                 | <b>BV2</b>           |
|                                  | long                   | <b>BV3</b>           |
| Stand Recognition Beep           | disable                | <b>Ba0</b>           |
|                                  | enable                 | <b>Ba1</b>           |
| Automatic Operation Aiming Light | disable                | <b>Bb0</b>           |
|                                  | enable                 | <b>Bb1</b>           |
| Aiming System                    | disable                | <b>BX0</b>           |
|                                  | 300 ms                 | <b>BX1</b>           |
|                                  | 500 ms                 | <b>BX2</b>           |
|                                  | 1 sec                  | <b>BX3</b>           |



| DECODING PARAMETERS |             |        |
|---------------------|-------------|--------|
| DESCRIPTION         |             | STRING |
| Ink-spread          | disable     | AX0    |
|                     | enable      | AX1    |
| Overflow control    | disable     | AW1    |
|                     | enable      | AW0    |
| Interdigit control  | disable     | AV0    |
|                     | enable      | AV1    |
| Decoding Safety     | one read    | ED0    |
|                     | two reads   | ED1    |
|                     | three reads | ED2    |
|                     | four reads  | ED3    |
| PuzzleSolver™       | disable     | AU0    |
|                     | enable      | AU1    |

| CODE SELECTION           |                                 |                         |      |
|--------------------------|---------------------------------|-------------------------|------|
| DESCRIPTION              |                                 | STRING                  |      |
| DISABLE ALL FAMILY CODES |                                 | AZ0                     |      |
| EAN/UPC                  | disable EAN/UPC family          |                         | AA0  |
|                          | EAN 8/EAN 13/UPC A/UPC E        | without ADD ON          | AA1  |
|                          |                                 | with ADD ON             | AA5  |
|                          |                                 | with and without ADD ON | AA8  |
|                          | EAN 8/EAN 13                    | without ADD ON          | AA3  |
|                          |                                 | with ADD ON 2 ONLY      | AAK  |
|                          |                                 | with ADD ON 5 ONLY      | AAL  |
|                          |                                 | with ADD ON 2 AND 5     | AA6  |
|                          | UPC A/UPC E                     | without ADD ON          | AA4  |
|                          |                                 | with ADD ON 2 ONLY      | AAM  |
|                          |                                 | with ADD ON 5 ONLY      | AAN  |
|                          |                                 | with ADD ON 2 AND 5     | AA7  |
|                          | EAN 8 check digit transmission  | disable                 | AAG0 |
|                          |                                 | enable                  | AAG1 |
|                          | EAN 13 check digit transmission | disable                 | AAH0 |
|                          |                                 | enable                  | AAH1 |
|                          | UPC A check digit transmission  | disable                 | AAI0 |
|                          |                                 | enable                  | AAI1 |
|                          | UPC E check digit transmission  | disable                 | AAJ0 |
|                          |                                 | enable                  | AAJ1 |
| conversions              | UPC E to UPC A                  | AAA                     |      |
|                          | UPC E to EAN 13                 | AAB                     |      |
|                          | UPC A to EAN 13                 | AAC                     |      |
|                          | EAN 8 to EAN 13                 | AAD                     |      |

| CODE SELECTION (continued) |                         |  |                  |
|----------------------------|-------------------------|--|------------------|
| DESCRIPTION                |                         | STRING                                   |                  |
|                            | ISBN Conversion codes   | enable ISBN                              | AP1              |
|                            |                         | enable ISSN                              | AP2              |
|                            |                         | enable ISBN and ISSN                     | AP3              |
|                            |                         | disable ISBN and ISSN                    | AP0              |
| Code 39                    | disable Code 39 family  |  | AB0              |
|                            | Standard                | no check digit control                   | AB11             |
|                            |                         | check digit control and transmission     | AB12             |
|                            |                         | check digit control without transmission | AB13             |
|                            | Full ASCII              | no check digit control                   | AB21             |
|                            |                         | check digit control and transmission     | AB22             |
|                            |                         | check digit control without transmission | AB23             |
|                            | CIP 39                  |  | AB3              |
| Code 32                    |                         | AB4                                      |                  |
| code length                |                         | AB* <i>xxxx</i>                          |                  |
| 2/5                        | disable Code 2/5 family |  | AC0              |
|                            | Interleaved 2/5         | no check digit control                   | AC11 <i>xxxx</i> |
|                            |                         | check digit control and transmission     | AC12 <i>xxxx</i> |
|                            |                         | check digit control without transmission | AC13 <i>xxxx</i> |
|                            | Normal 2/5 5 bars       | no check digit control                   | AC21 <i>xxxx</i> |
|                            |                         | check digit control and transmission     | AC22 <i>xxxx</i> |
|                            |                         | check digit control without transmission | AC23 <i>xxxx</i> |
|                            | Industrial 2/5 (IATA)   | no check digit control                   | AC31 <i>xxxx</i> |
|                            |                         | check digit control and transmission     | AC32 <i>xxxx</i> |
|                            |                         | check digit control without transmission | AC33 <i>xxxx</i> |
|                            | Matrix 2/5 3 bars       | no check digit control                   | AC41 <i>xxxx</i> |
|                            |                         | check digit control and transmission     | AC42 <i>xxxx</i> |
|                            |                         | check digit control without transmission | AC43 <i>xxxx</i> |
|                            | CIP/HR                  |  | AC5              |

*xxxx* = ASCII numbers that define the code length where:

- First 2 digits = minimum acceptable code length.
- Second 2 digits = maximum acceptable code length.

The minimum code length must always be less than or equal to the maximum. The maximum code lengths are **99** characters.

**Examples:**

0132 = variable length from 1 to 32 digits in the code.

1010 = 10 digit code length only.

| CODE SELECTION (continued)                |   |   |                |
|---|---|---|----------------|
| DESCRIPTION                               |   | STRING  |                |
| Codabar                                   | disable Codabar family  |   | <b>AD0</b>     |
|   | Standard  | no start/stop character equality control nor transmission | <b>AD111</b>   |
|   |   | no start/stop character equality control but transmission | <b>AD112</b>   |
|   |   | start/stop character equality control but no transmission | <b>AD121</b>   |
|   |   | start/stop character equality control and transmission    | <b>AD122</b>   |
|   | ABC Codabar   | no start/stop character equality control but transmission | <b>AD212</b>   |
|   | Codabar ABC forced concatenation                              |   | <b>AD232</b>   |
|   | code length   |   | <b>AD*xxxx</b> |
| start/stop character case in transmission | lower case  | <b>ADA0</b>   |                |
|   | upper case  | <b>ADA1</b>   |                |
| Code 128                                  | disable Code 128 family                                       |   | <b>AI0</b>     |
|   | enable Code 128 - control without transmission of check digit |   | <b>AI11</b>    |
|   | enable EAN 128 - control without transmission of check digit  |   | <b>AI21</b>    |
|   | add GS before Code  | disable   | <b>EQ0</b>     |
|   |   | enable  | <b>EQ1</b>     |
|   | ISBT 128  | enable ISBT 128   | <b>AI31</b>    |
| code length                               |   | <b>AILxxxx</b>  |                |
| Code 93                                   | disable Code 93 family  |   | <b>AK0</b>     |
|   | enable Code 93 - control without transmission of check digit  |   | <b>AK1</b>     |
| MSI                                       | disable the family  |   | <b>AE0</b>     |
|   | no check  |   | <b>AE1</b>     |
|   | MOD10 no tx   |   | <b>AE2</b>     |
|   | MOD10 with tx   |   | <b>AE3</b>     |
|   | MOD11-MOD10 no tx   |   | <b>AE4</b>     |
|   | MOD11-MOD10 with tx   |   | <b>AE5</b>     |
|   | MOD10-MOD10 no tx   |   | <b>AE6</b>     |
|   | MOD10-MOD10 with tx   |   | <b>AE7</b>     |

**xxxx** = ASCII numbers that define the code length where:

- First 2 digits = minimum acceptable code length.
- Second 2 digits = maximum acceptable code length.

The minimum code length must always be less than or equal to the maximum. The maximum code lengths are **99** characters.

**Examples:**

0132 = variable length from 1 to 32 digits in the code.

1010 = 10 digit code length only.

| <b>CODE SELECTION (continued)</b> |   |               |
|-----------------------------------|---|---------------|
| <b>DESCRIPTION</b>                |   | <b>STRING</b> |
| Plessey                           | disable the family                      | <b>AF0</b>    |
|                                   | Standard no check                       | <b>AF11</b>   |
|                                   | Standard check - with tx                | <b>AF12</b>   |
|                                   | Standard check - no tx                  | <b>AF13</b>   |
|                                   | Anker no check                          | <b>AF21</b>   |
|                                   | Anker check - with tx                   | <b>AF22</b>   |
|                                   | Anker check - no tx                     | <b>AF23</b>   |
| Telepen                           | disable the family                      | <b>AL0</b>    |
|                                   | Numeric no check                        | <b>AL11</b>   |
|                                   | Numeric check - with tx                 | <b>AL12</b>   |
|                                   | Numeric check - no tx                   | <b>AL13</b>   |
|                                   | Alpha no check                          | <b>AL21</b>   |
|                                   | Alpha check - with tx                   | <b>AL22</b>   |
|                                   | Alpha check - no tx                     | <b>AL23</b>   |
| Delta IBM                         | disable the family                      | <b>AH0</b>    |
|                                   | no check                                | <b>AH1</b>    |
|                                   | Type 1 check                            | <b>AH2</b>    |
|                                   | Type 2 check                            | <b>AH3</b>    |
| Code 11                           | disable the family                      | <b>AG0</b>    |
|                                   | no check                                | <b>AG1</b>    |
|                                   | Type C with tx                          | <b>AG21</b>   |
|                                   | Type C no tx                            | <b>AG22</b>   |
|                                   | Type K with tx                          | <b>AG31</b>   |
|                                   | Type K no tx                            | <b>AG32</b>   |
|                                   | Type C and K with tx                    | <b>AG41</b>   |
|                                   | Type C and K no tx                      | <b>AG42</b>   |
| Code 16K                          | disable                                 | <b>AJ0</b>    |
|                                   | enable                                  | <b>AJ1</b>    |
| Code 49                           | disable                                 | <b>AM0</b>    |
|                                   | enable                                  | <b>AM1</b>    |
| RSS Codes                         | disable the family                      | <b>AQ0</b>    |
|                                   | disable RSS Expanded Linear and Stacked | <b>AQ10</b>   |
|                                   | enable RSS Expanded Linear and Stacked  | <b>AQ11</b>   |
|                                   | disable RSS Limited                     | <b>AQ20</b>   |
|                                   | enable RSS Limited                      | <b>AQ21</b>   |
|                                   | disable RSS 14 Linear and Stacked       | <b>AQ30</b>   |
|                                   | enable RSS 14 Linear and Stacked        | <b>AQ31</b>   |

---

**B CODE IDENTIFIER TABLE**

---

2/5 Interleaved



2/5 Industrial



2/5 normal 5 bars



2/5 matrix 3 bars



EAN 8



EAN 13



UPC A



UPC E



EAN 8 with 2 ADD ON



EAN 8 with 5 ADD ON



EAN 13 with 2 ADD ON



EAN 13 with 5 ADD ON



**UPC A with 2 ADD ON**



**UPC A with 5 ADD ON**



**UPC E with 2 ADD ON**



**UPC E with 5 ADD ON**



**Code 39**



**Code 39 Full ASCII**



**CODABAR**



**ABC CODABAR**



**Code 128**



**EAN 128**



**ISBT 128**















**CIP/HR**



**CIP/39**



|  |   |
|--|---|
|  | <b>Code 32</b><br>                           |
| <b>Code 93</b><br>          |   |
|  | <b>MSI</b><br>                               |
| <b>Plessey Standard</b><br> |   |
|  | <b>Plessey Anker</b><br>                     |
| <b>Delta IBM</b><br>        |   |
|  | <b>Telepen</b><br>                           |
| <b>Code 16K</b><br>         |   |
|  | <b>Code 11</b><br>                          |
| <b>Code 49</b><br>        |   |
|  | <b>RSS Expanded Linear and Stacked</b><br> |
| <b>RSS Limited</b><br>    |   |
|  | <b>RSS 14 Linear and Stacked</b><br>       |

**C HEX AND NUMERIC TABLE**

| CHARACTER TO HEX CONVERSION TABLE |     |      |     |      |     |
|-----------------------------------|-----|------|-----|------|-----|
| char                              | hex | char | hex | char | hex |
| NUL                               | 00  | *    | 2A  | U    | 55  |
| SOH                               | 01  | +    | 2B  | V    | 56  |
| STX                               | 02  | ,    | 2C  | W    | 57  |
| ETX                               | 03  | -    | 2D  | X    | 58  |
| EOT                               | 04  | .    | 2E  | Y    | 59  |
| ENQ                               | 05  | /    | 2F  | Z    | 5A  |
| ACK                               | 06  | 0    | 30  | [    | 5B  |
| BEL                               | 07  | 1    | 31  | \    | 5C  |
| BS                                | 08  | 2    | 32  | ]    | 5D  |
| HT                                | 09  | 3    | 33  | ^    | 5E  |
| LF                                | 0A  | 4    | 34  | ~    | 5F  |
| VT                                | 0B  | 5    | 35  |      | 60  |
| FF                                | 0C  | 6    | 36  | a    | 61  |
| CR                                | 0D  | 7    | 37  | b    | 62  |
| SO                                | 0E  | 8    | 38  | c    | 63  |
| SI                                | 0F  | 9    | 39  | d    | 64  |
| DLE                               | 10  | :    | 3A  | e    | 65  |
| DC1                               | 11  | ;    | 3B  | f    | 66  |
| DC2                               | 12  | <    | 3C  | g    | 67  |
| DC3                               | 13  | =    | 3D  | h    | 68  |
| DC4                               | 14  | >    | 3E  | i    | 69  |
| NAK                               | 15  | ?    | 3F  | j    | 6A  |
| SYN                               | 16  | @    | 40  | k    | 6B  |
| ETB                               | 17  | A    | 41  | l    | 6C  |
| CAN                               | 18  | B    | 42  | m    | 6D  |
| EM                                | 19  | C    | 43  | n    | 6E  |
| SUB                               | 1A  | D    | 44  | o    | 6F  |
| ESC                               | 1B  | E    | 45  | p    | 70  |
| FS                                | 1C  | F    | 46  | q    | 71  |
| GS                                | 1D  | G    | 47  | r    | 72  |
| RS                                | 1E  | H    | 48  | s    | 73  |
| US                                | 1F  | I    | 49  | t    | 74  |
| SPACE                             | 20  | J    | 4A  | u    | 75  |
| !                                 | 21  | K    | 4B  | v    | 76  |
| "                                 | 22  | L    | 4C  | w    | 77  |
| #                                 | 23  | M    | 4D  | x    | 78  |
| \$                                | 24  | N    | 4E  | y    | 79  |
| %                                 | 25  | O    | 4F  | z    | 7A  |
| &                                 | 26  | P    | 50  | {    | 7B  |
| '                                 | 27  | Q    | 51  |      | 7C  |
| (                                 | 28  | R    | 52  | }    | 7D  |
| )                                 | 29  | S    | 53  | ~    | 7E  |
|                                   |     | T    | 54  | DEL  | 7F  |



| CHARACTER TO HEX CONVERSION TABLE |     |      |     |          |     |
|-----------------------------------|-----|------|-----|----------|-----|
| char                              | hex | char | hex | char     | hex |
| €                                 | 80  | ª    | AA  | Õ        | D5  |
| □                                 | 81  | «    | AB  | Ö        | D6  |
| ,                                 | 82  | ¬    | AC  | ×        | D7  |
| ENTER                             | 83  | -    | AD  | Ø        | D8  |
| TAB                               | 84  | ®    | AE  | Ù        | D9  |
| F1                                | 85  | —    | AF  | Ú        | DA  |
| F2                                | 86  | °    | B0  | Û        | DB  |
| F3                                | 87  | ±    | B1  | Ü        | DC  |
| F4                                | 88  | ²    | B2  | Ý        | DD  |
| F5                                | 89  | ³    | B3  | Þ        | DE  |
| F6                                | 8A  | ´    | B4  | ß        | DF  |
| F7                                | 8B  | µ    | B5  | à        | E0  |
| F8                                | 8C  | ¶    | B6  | á        | E1  |
| F9                                | 8D  | ·    | B7  | â        | E2  |
| F10                               | 8E  | ,    | B8  | ã        | E3  |
| F11                               | 8F  | í    | B9  | ä        | E4  |
| F12                               | 90  | °    | BA  | å        | E5  |
| HOME                              | 91  | »    | BB  | æ        | E6  |
| END                               | 92  | ¼    | BC  | ç        | E7  |
| Pg UP                             | 93  | ½    | BD  | è        | E8  |
| Pg Down                           | 94  | ¾    | BE  | é        | E9  |
| ↑                                 | 95  | ¿    | BF  | ê        | EA  |
| ↓                                 | 96  | À    | C0  | ë        | EB  |
| ←                                 | 97  | Á    | C1  | ì        | EC  |
| →                                 | 98  | Â    | C2  | í        | ED  |
| ESC                               | 99  | Ã    | C3  | î        | EE  |
| CTRL(Right)                       | 9A  | Ä    | C4  | ï        | EF  |
| €                                 | 9B  | Å    | C5  | ð        | F0  |
| œ                                 | 9C  | Æ    | C6  | ñ        | F1  |
| □                                 | 9D  | Ç    | C7  | ò        | F2  |
| ž                                 | 9E  | È    | C8  | ó        | F3  |
| ÿ                                 | 9F  | É    | C9  | ô        | F4  |
| NBSP                              | A0  | Ê    | CA  | õ        | F5  |
| ı                                 | A1  | Ë    | CB  | ö        | F6  |
| ¢                                 | A2  | Ì    | CC  | ÷        | F7  |
| £                                 | A3  | Í    | CD  | ø        | F8  |
| ¤                                 | A4  | Î    | CE  | ù        | F9  |
| ¥                                 | A5  | Ï    | CF  | ú        | FA  |
| ¦                                 | A6  | Ð    | D0  | û        | FB  |
| §                                 | A7  | Ñ    | D1  | ü        | FC  |
| ¨                                 | A8  | Ò    | D2  | ý        | FD  |
| ©                                 | A9  | Ó    | D3  | Reserved | FE  |
|                                   |     | Ô    | D4  | Reserved | FF  |

# HEX / NUMERIC TABLE



0



2



4



6



8



A



C



E



1



3



5



7



9



B



D



F

Backspace



Cancels an incomplete configuration sequence

**Australia**

Datalogic Scanning Pty Ltd  
North Ryde, Australia  
Telephone: [61] (2) 9870 3200  
Fax: [61] (2) 9878 8688

**France and Benelux**

Datalogic Scanning Sarl  
LES ULIS Cedex, France  
Telephone: [33].01.64.86.71.00  
Fax: [33].01.64 46.72.44

**Germany**

Datalogic Scanning GmbH  
Darmstadt, Germany  
Telephone: 49 (0) 61 51/93 58-0  
Fax: 49 (0) 61 51/93 58 58

**Italy**

Datalogic Scanning SpA  
Vimercate (MI), Italy  
Telephone: [39] (0) 39/62903.1  
Fax: [39] (0) 39/6859496

**Japan**

Datalogic Scanning KK  
Shinagawa, Tokyo, Japan  
Telephone: 81 (0)3 3491 6761  
Fax: 81 (0)3 3491 6656

**Latin America**

Datalogic Scanning, Inc  
Miami, Florida, USA  
Telephone: (305) 591-3222  
Fax: (305) 591-3007

**Spain and Portugal**

Datalogic Scanning Sarl  
Sucursal en España  
Madrid, Spain  
Telephone: 34 91 746 28 60  
Fax: 34 91 742 35 33

**United Kingdom**

Datalogic Scanning LTD  
Watford, England  
Telephone: 44 (0) 1923 809500  
Fax: 44 (0) 1923 809 505



[www.scanning.datalogic.com](http://www.scanning.datalogic.com)

**Datalogic Scanning, Inc.**

959 Terry Street  
Eugene, OR 97402  
Telephone: (541) 683-5700  
Fax: (541) 345-7140